



2023

ANTABY-POCHWYTY



POSTAL[®]
STEEL GROUP



STYLOWE
NOWOCZESNE
EKSKLUZYWNE



Pochwyty z serii x7z0 przeznaczone do modernistycznych obiektów publicznych, przestrzeni biurowych i prywatnych. Stanowią eleganckie i funkcjonalne dopełnienie drzwi szklanych, drewnianych, metalowych oraz z tworzywa. Doskonała propozycja do drzwi przesuwanych – zwłaszcza w industrialnych i loftowych wnętrzach.

POCHWYT DWUSTRONNY PROSTOKĄTNY 90° – STALOWY, 40 × 500 mm

AISI304, uniwersalny, czarny

64.P9DP90500.SUM



Ø	a	b	kolor	materiał	waga
40	450	410	czarny	AISI304	5 kg

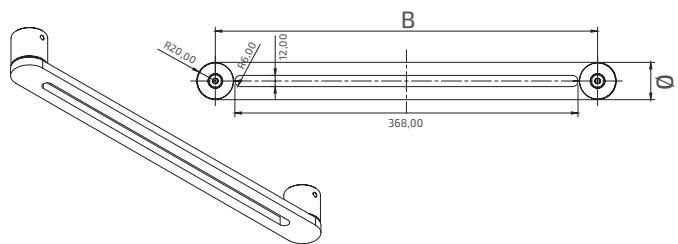
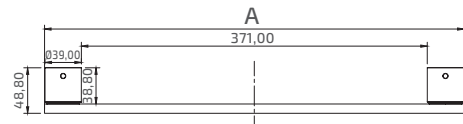

DOWIEDZ SIĘ
WIĘCEJ

POCHWYT DWUSTRONNY PROSTOKĄTNY 90° – STALOWY, 40 × 500 mm

AISI304, uniwersalny, czarny

64.P10DP90500.SUM



Ø	a	b	kolor	materiał	waga
40	493	435	czarny	AISI304	5 kg

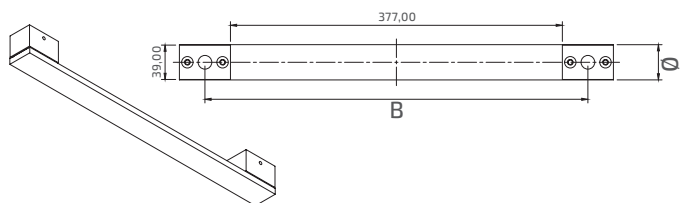

DOWIEDZ SIĘ
WIĘCEJ

POCHWYT DWUSTRONNY OKRĄGŁY 90°, 30 × 500 mm

AISI304, uniwersalny, satynowy

N64.P6DO90500.4US

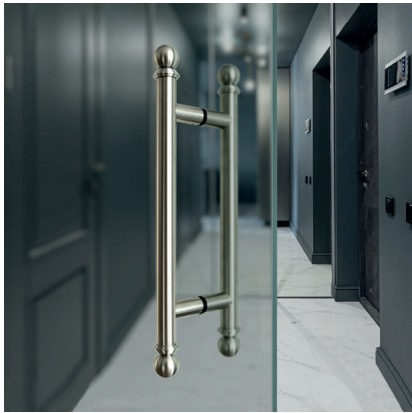

Ø	a	b	kolor	materiał	waga
30	500	300	satyna	AISI304	5 kg

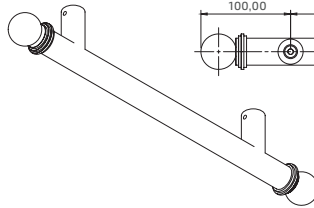
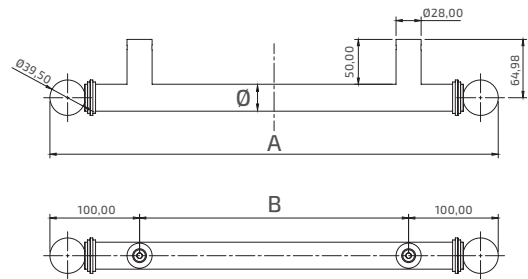

DOWIEDZ SIĘ
WIĘCEJ

POCHWYT DWUSTRONNY PROSTOKĄTNY 90° – STALOWY, 40 × 500 mm

AISI304, uniwersalny, czarny, malowany

64.P7DP90500.SUM

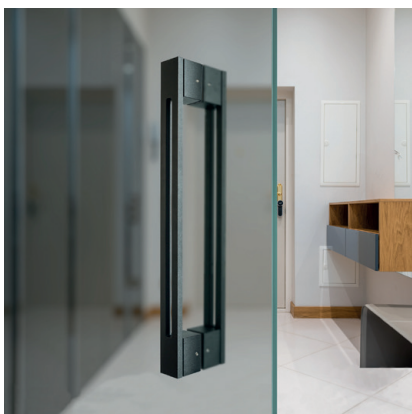

Ø	a	b	kolor	materiał	waga
40	478	358	czarny	AISI304	5 kg

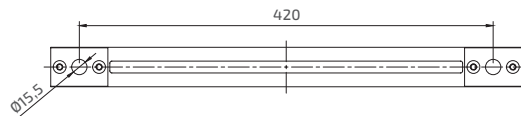
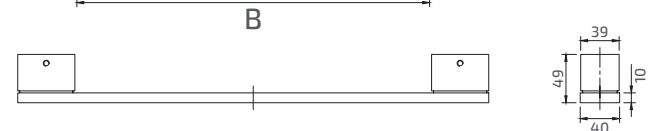
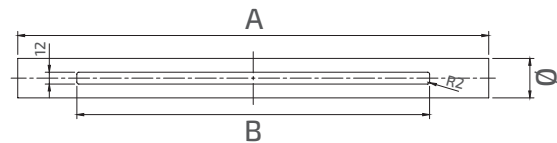

DOWIEDZ SIĘ
WIĘCEJ

POCHWYT DWUSTRONNY PROSTOKĄTNY 90° – 50 × 500 mm

uniwersalny, aluminiowy z elementami drewnianymi

N64.P8DP90500.AUM

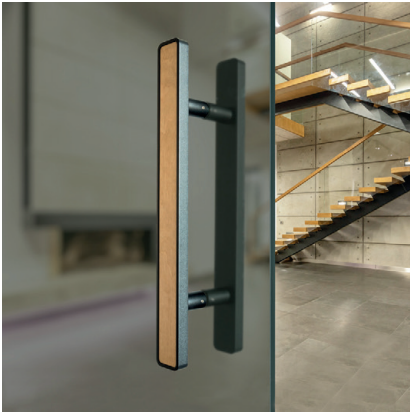

Ø	a	b	kolor	materiał	waga
50	489	300	czarny	aluminium drewno	4 kg

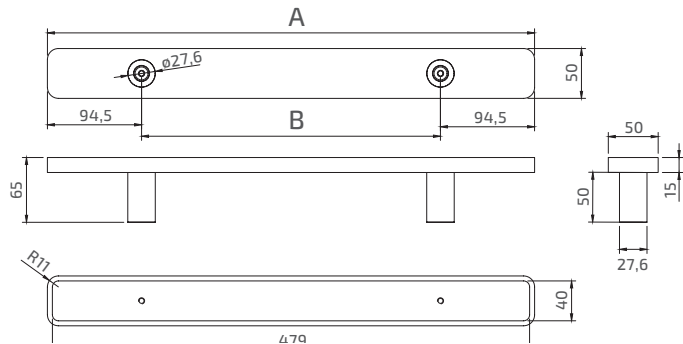

**DOWIEDZ SIĘ
WIĘCEJ**

POCHWYT DWUSTRONNY OKRĄGŁY 90°, CZARNY, 30 × 500 mm

AISI304, uniwersalny, malowany

N64.P5DO90500.4UM



Ø	a	b	kolor	materiał	waga
30	500	80	czarny	AISI304	2 kg

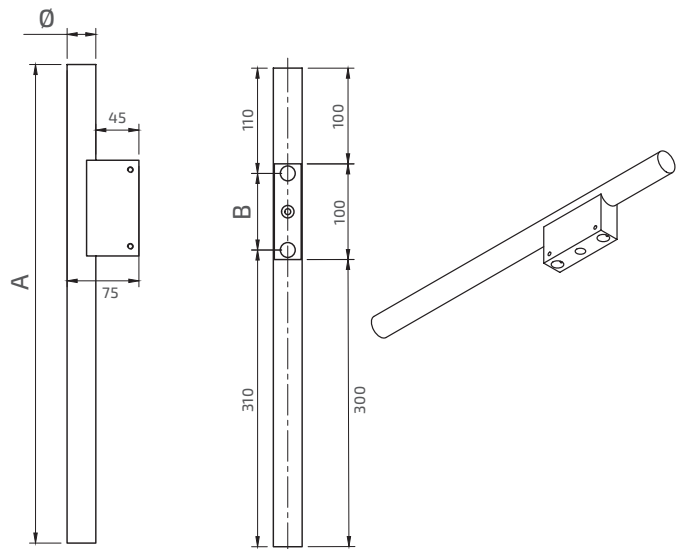

**DOWIEDZ SIĘ
WIĘCEJ**

POCHWYT DWUSTRONNY OKRĄGŁY 90°, CZARNY, 30 × 500 mm

AISI304, uniwersalny, malowany, drewno

N64.P3D090500.4UM

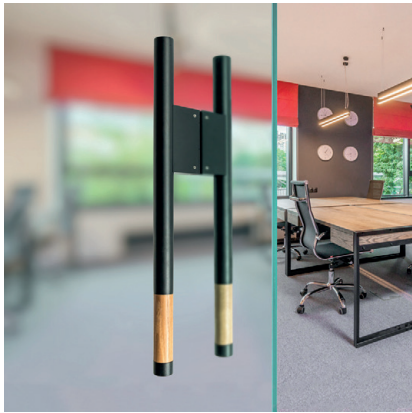

Ø	a	b	kolor	materiał	waga
30	500	80	czarny	aluminium drewno	2 kg

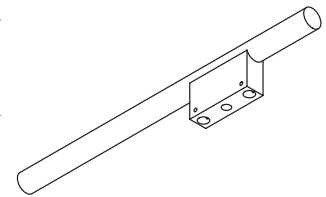
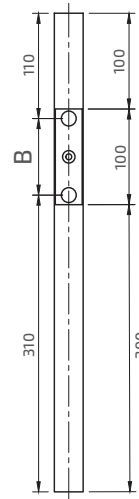
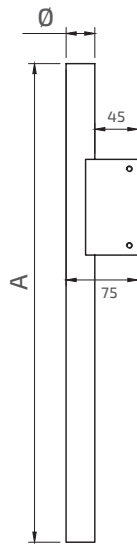

**DOWIEDZ SIĘ
WIĘCEJ**

POCHWYT DWUSTRONNY OKRĄGŁY 90°, CZARNY WSPORNIK, 30 × 500 mm

AISI304, uniwersalny, satynowy

N64.P4D090500.4US



Ø	a	b	kolor	materiał	waga
30	500	80	satyna czarny	AISI304 aluminium	2 kg

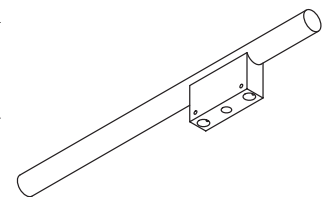
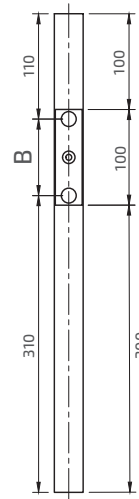
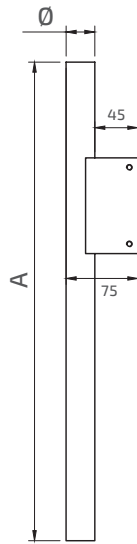

**DOWIEDZ SIĘ
WIĘCEJ**

xy7zo





PINOX PSG

STAR FLEX

STAR WIRE

Platinum

SEA

KOZSA
Rolling Systems

POSTAL[®]
STEEL GROUP

POSTAL STEEL GROUP POLSKA Sp. z o.o.

ul. Sowie 6 | Park Przemysłowy „Sowia”,
62-080 Tarnowo Podgórne

+48 61 648 28 28

✉ e-mail: info@postal.pl
🌐 postal.pl