

POSTAL[®]
STEEL GROUP

STALOWE ELEMENTY KUTE DO BRAM, OGRODZEŃ I BALUSTRAD

Forged steel components / Кованные элементы / Schmiedeeisen



30 lat
POSTAL[®]
STEEL GROUP

POSTAL STEEL GROUP POLSKA działa w branży metalowej od 30 lat. Oferujemy szeroką gamę stalowych elementów kutych do bram i ogrodzeń, a także elementy ze stali nierdzewnej i akcesoria spawalnicze. Naszym celem jest dostarczanie klientom produktów najwyższej jakości oraz zapewnienie doskonałego serwisu.

Zatrudniamy ponad 30 doświadczonych mobilnych i stacjonarnych handlowców, którzy pomagają klientom wybrać najlepsze produkty z naszego szerokiego asortymentu.

Cały czas pracujemy też nad poszerzeniem naszej oferty, tworząc marki takie jak:

POSTAL – stalowe elementy kute, PINOX – produkty ze stali nierdzewnej, PSG – akcesoria do bram i ogrodzeń, STARFLEX – tarcze do cięcia i szlifowania, STAR WIRE i PLATINIUM – druty i akcesoria spawalnicze.

Dbamy o najwyższą jakość powyższych marek, dlatego większość naszego towaru pochodzi z polskich i europejskich zakładów produkcyjnych, dzięki którym produkty są nieustannie doskonałe.

W Europie Środkowej jesteśmy liderem w swojej branży, a marka POSTAL jest szeroko znana w Polsce i poza nią. Dokładamy wszelkich starań, aby zawsze mogli Państwo polegać na jakości naszych usług i produktów.

POSTAL STEEL GROUP POLSKA has been operating in the metal industry for 30 years. We offer a wide range of forged steel components for gates and fences, as well as stainless steel elements and welding accessories. Since the very beginning our goal is to provide clients with the best possible service and highest quality products.

We employ over 30 experienced mobile and stationary advisers, who help our clients choose goods most suitable for them from our varied assortment.

We are constantly working on widening our offer by creating brands such as:

POSTAL – forged steel components, PINOX – stainless steel products, PSG – accessories for gates and fences, STARFLEX – cutting and grinding discs, STAR WIRE and PLATINIUM – welding wire and accessories.

To make sure that each brand offers the best quality products, we base major part of our production in our industrial plants based in Poland and Europe.

In Central Europe we are the leaders in our field and the brand POSTAL is well known in Poland and abroad. We will make every effort so that you associate our company and brands with the highest quality and reliability.



30^{lat}
POSTAL[®]
STEEL GROUP

POSTAL STEEL GROUP POLSKA 30 лет работает в секторе металлургической промышленности. Мы предлагаем широкий ассортимент кованных стальных элементов для ворот и заборов, а также элементов из нержавеющей стали и сварочных аксессуаров. Наша цель – предоставить клиентам продукцию высокого качества и обеспечить отличный сервис.

У нас работает более 30 опытных мобильных и местных консультантов, которые помогают клиентам при выборе нужных продуктов из нашего ассортимента.

Мы также работаем над расширением нашего предложения, создавая такие бренды, как:

POSTAL – стальные кованные элементы, PINOX – изделия из нержавеющей стали, PSG – аксессуары для ворот и заборов, STARFLEX – диски для резки и шлифовки, STAR WIRE и PLATINIUM – высококачественные проволоки и аксессуары для сварки

Мы заботимся о высоком качестве этих брендов, поэтому большая часть наших продуктов поставляется на польских и европейских заводах, благодаря чему продукция постоянно совершенствуется.

В Центральной Европе мы являемся лидером в нашей отрасли, а бренд POSTAL широко известен в Польше и за рубежом.

POSTAL STEEL GROUP POLSKA ist seit 30 Jahren der Lieferant von hochwertigen Produkten in der Stahlbranche. Wir bieten breite Palette von sowohl Stahl- und Edelstahlelemente für Tore und Zäune als auch Schweißzubehör vor. Unser Ziel ist es, den Kunden Produkte von höchster Qualität zu liefern und einen exzellenten Kundenservice zu sichern.

Unser Team aus über 30 Mitarbeiterinnen und Mitarbeitern im Innen- und Außendienst berät kompetent und freundlich den Kunden bei der Wahl richtiger Produkten.

Wir arbeiten stets daran, damit unser Angebot sich erweitert und so sind folgende Marken entstanden wie:

POSTAL – geschmiedete Stahlelemente, PINOX – Edelstahlelemente, PSG – Zubehör für Tore und Zäune, STARFLEX – Schneid- und Schleifscheiben STAR WIRE und PLATINIUM – Schweißdrähte und Zubehör.

Wir achten auf die höchste Qualität der oben genannten Marken, deshalb kommt der größte Teil dieser Produkten von polnischen und europäischen Herstellern und wird ständig verbessert.

In Zentraleuropa sind wir führender Lieferant und die Marke POSTAL ist in Polen und im Ausland weithin bekannt. Wir streben uns danach, dass Sie sich auf die Qualität unserer Dienstleistungen und Produkte immer verlassen könnten.



NASI PARTNERZY

Our partners / Наши партнеры / Unsere Partner

W ofercie posiadamy asortyment czółowych producentów europejskich:

We provide products of leading european manufacturers:

Предлагаем аксессуары ведущих европейских производителей:

Wir bieten ein umfangreiches Sortiment von führenden europäischen Herstellern an:

LOCINOX

Okucia do ogrodzeń

Gate and fencing accessories /
Фурнитура для ограждений /
Baubeschläge für Zäune und Tore



SEA

Automatyka do bram

Gate automation /
Автоматика для ворот /
Torantriebe

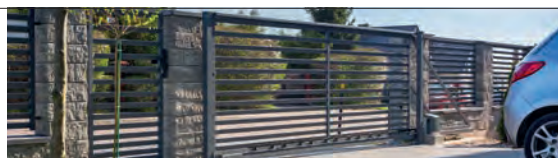

BENINCA
AUTOMATYKA DO BRAM

Automatyka do bram

Gate automation /
Автоматика для ворот /
Torantriebe



BFT

Automatyka do bram

Gate automation /
Автоматика для ворот /
Torantriebe

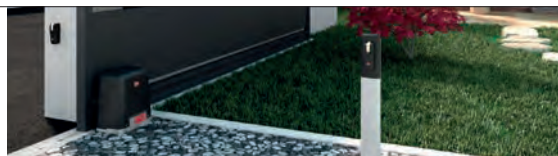

CAME

Automatyka do bram

Gate automation /
Автоматика для ворот /
Torantriebe



FAAC
Simply automatic.

Automatyka do bram

Gate automation /
Автоматика для ворот /
Torantriebe



Nice

Automatyka do bram

Gate automation /
Автоматика для ворот /
Torantriebe



ASSA ABLOY

Zabezpieczenia

Security solutions /
Sicherungen /
Защита



GATEMASTER

Mechaniczne zamki i zaczepy

Mechanical locks and catches /
Schlösser und Anschläge /
Механические замки и защелки



ABUS
Security Tech Germany

Technologie bezpieczeństwa

Security technologies /
Sicherungs Technologien /
Технологии безопасности



NASZE MARKI

Our brands / Наши бренды / Unsere Marken



POSTAL[®]
STEEL GROUP

Stalowe elementy kute

Forged steel components /
Стальные кованные элементы /
Die geschmiedete Stahlelemente



BONMARIO

Sklep internetowy bonmario.com

Online Shop /
Интернет-магазин /
Online-Shop



PINOX

Produkty ze stali nierdzewnej

Stainless steel products /
Товары из нержавеющей стали /
Produkten aus Edelstahl



PSG

Akcesoria do bram i ogrodzeń

Accessories for gates and fences /
Аксессуары для ворот и ограждений /
Zubehör für Tore und Zäune



STAR FLEX

Tarcze do cięcia i szlifowania

Cutting and grinding discs /
Диски для резки и шлифовки /
Scheiben zum Schneiden und Schleifen



STAR WIRE

Drut spawalniczy

Welding wire /
Сварочная проволока /
Schweißdraht



Platinum

Drut spawalniczy

Welding wire /
Сварочная проволока /
Schweißdraht





SATURN SUPER FAST 500 24V

najszybszy napęd
do bramy przesuwnej

#nr 1 na rynku



MOCNE WNĘTRZE! NAJWYŻSZA JAKOŚĆ!



Produkty na zamówienie – skontaktuj się z biurem obsługi

Products available for special order - contact customer service /

Продукты доступны по специальному заказу – свяжитесь с продавцом /

Produkt auf Bestellung

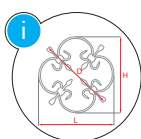

Spójne wymiarowanie produktów w kategoriach

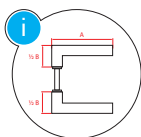

Dimensions measurements compatible in each category /

Соответствующие размеры продуктов в категориях /

Feste Bemaßung den Produkten in Kategorien

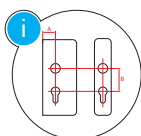

[mm]

Wszystkie wymiary podane w milimetrach

All dimensions in mm / Все параметры указаны в мм / Alle Abmessungen in mm

Zastrzega się możliwość zmian technologicznych lub odchyień od wymiarów. Produkty oryginalne mogą się różnić od przedstawionych na zdjęciach.



We inform that technological changes and size deviations of the products are possible. The original products might be different than the ones presented on the pictures.

Мы оставляем за собой право технологических изменений или отклонений от заданных размеров в каталоге. Оригинальный продукт может отличаться от приведенных на фотографиях.

Die Möglichkeit der technologischen Änderungen oder Abweichung von gegebenen Abmessungen im Katalog sind vorbehalten. Originelle Produkten können sich ansatzweise von den präsentierten Fotos unterscheiden

Wszystkie treści, materiały, zdjęcia oraz elementy graficzne umieszczone w niniejszym katalogu stanowią własność POSTAL STEEL GROUP POLSKA sp. z o.o. z siedzibą w Tarnowie Podgórnym („Spółka”) i są utworami w rozumieniu ustawy z dnia 4 lutego 1994 r. o prawie autorskim i prawach pokrewnych (t.j.: Dz. U. z 2018 r., poz. 1191 z późn. zm.). Żaden z powyższych utworów nie może być ani w całości, ani w części rozpowszechniany lub kopiowany w jakikolwiek sposób (elektroniczny, mechaniczny lub inny) bez zgody Spółki wyrażonej na piśmie pod rygorem nieważności. Jakiegokolwiek naruszenie uprawnień Spółki skutkować będzie wszczęciem czynności mających na celu uruchomienie środków ochrony prawnej przysługującej Spółce.

	10.089 - 11.332	ELEMENTY SPIRALNE scrolls / спиральные элементы / Spiralelemente	11
	12.010 - 12.150	KOSZYKI baskets / корзины / Zwirbeln	19
	13.000 - 13.323	ROZETY rosettes / розетки / Rosetten	23
	20.001 - 24.266	TRALKI I SŁUPY balusters and baluster posts / балясины / Stäbe und Brüstungspfosten	43
	30.001 - 31.404	PŁASKOWNIKI I TAŚMY flat bars and banding materials / полосы и ленты / Flacheisen und Hespeneisen	55
	30.020 - 34.231	PROFILE ZAMKNIĘTE I PRĘTY OZDOBNE bars and decorative bars / прутья и декоративные прутья / Vierkantrohre und decorative Stäbe	63
	40.001 - 40.300	GROTY spearheads / пики / Spitzen	71
	41.001 - 41.506	PRZEKUWKI ornamental steel collars/ насадки / Zierhülsen	81
	42.000 - 43.800.01	GAŁKI I KULE knobs and spheres / верхушки и шары / Pfostenaufsätze und Kugeln	89
	44.001 - 44.259.ZN	MASKOWNICE masking frames / маскировочные элементы / Abschlußrosetten	95
	50.000 - 51.452	KWIATY I LIŚCIE flowers and leaves / цветы и листья / Blumen und Blätter	103
	52.003 - 55.200	ODLEWY STALIWNE I ŹELIWNE cast steel items and cast iron items / литая сталь и чугунные элементы / Stahlguss und Gusseisenwaren	123
	56.010 - 56.090.12.01	BLACHY metal sheets / листовой металл / Stahlblech	134

	61.100 - 61.326	ZAWIASY TOCZONE I PASOWE hinges / петли / Scharniere und Ladenbänder	139
	62.101 - 62.104	DASZKI post caps / крышки / Deckel	150
	63.001 - 63.038	KLAMKI I UCHWYTY door handles / ручки / Türdrücker und Griffe	153
	63.040 - 63.194.90.00	SZYLDY shields / накладки / Schlosskastenblenden	161
	64.003 - 64.801	AKCESORIA MOCUJĄCE fixing elements / крепления / Befestigungszubehör	168
	65.200 - 65.259	SKRZYNKI NA LISTY mail boxes / почтовые ящики / Briefkästen	173
	66.003.01 - 66.006.01	LAMPY lamps / лампы / Lampen	177
	66.050 - 66.075	NOGI DO ŁAWEK bench legs / ножки для скамеек / Bankfüße	178
	70.001 - 70.123	FARBY I PATYNY paints and patinas / краски и патины / Farben und Patine	181
	71.001 - 75.041.01	KOTWY I AKCESORIA anchors and accessories / хемические анкера / Anker und Zubehör	186
	SP.001.08 - SWM.UCHWYT.01	DRUT I AKCESORIA SPAWALNICZE welding wire and accessories / сварочная проволока и принадлежности / Schweißdraht und Schweißzubehör	189
	TCI 115 10 22 - TZI 230 60 22	TARCZE discs / диски / Trennscheiben	196



ELEMENTY SPIRALNE

scrolls
спиральные элементы
Spiralelemente



10.089 - 11.332

POSTAL®

ELEMENTY SPIRALNE

scrolls / спиральные элементы / Spiralelemente



N

□	12x6	12x6	12x6	12x6	12x6	12x6	12x6	12x6	12x6	12x6	12x6
H	105	110	80	95	100	115	120	130	150	160	220
L	64	64	50	60	60	75	70	70	75	80	120
N°	10.089	10.090	10.091	10.092	10.093	10.094	10.095	10.096	10.097	10.098	10.099



□	12x6	12x6	12x6	12x6	12x6	12x6	12x6
H	150	230	260	170	195	300	330
L	70	115	115	80	90	120	130
N°	10.100	10.101	10.102	10.103	10.104	10.107	10.108

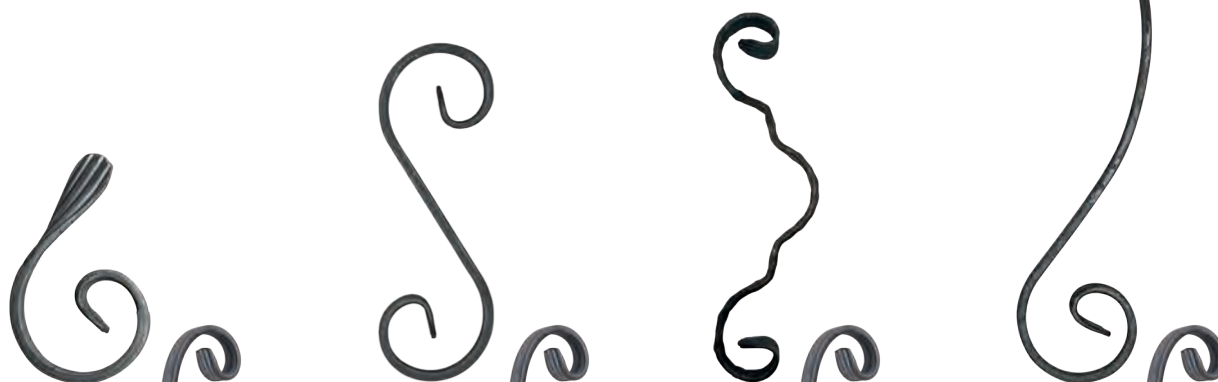

□	12x6	12x6	12x6	12x6
H	120	230	250	460
L	80	80	75	80
N°	10.109	10.116	10.125	10.130

ELEMENTY SPIRALNE

scrolls / спиральные элементы / Spiralemente

13



□	12x6	12x6	12x6	12x6	12x6	12x6
H	80	100	120	130	160	220
L	55	60	75	75	80	130
N°	10.200	10.201	10.202	10.203	10.204	10.205



□	12x6	12x6	12x6	12x6	12x6	12x6
H	150	170	220	270	300	330
L	70	80	100	110	120	130
N°	10.206	10.207	10.208	10.209	10.210	10.211



ELEMENTY SPIRALNE

scrolls / спиральные элементы / Spiralelemente

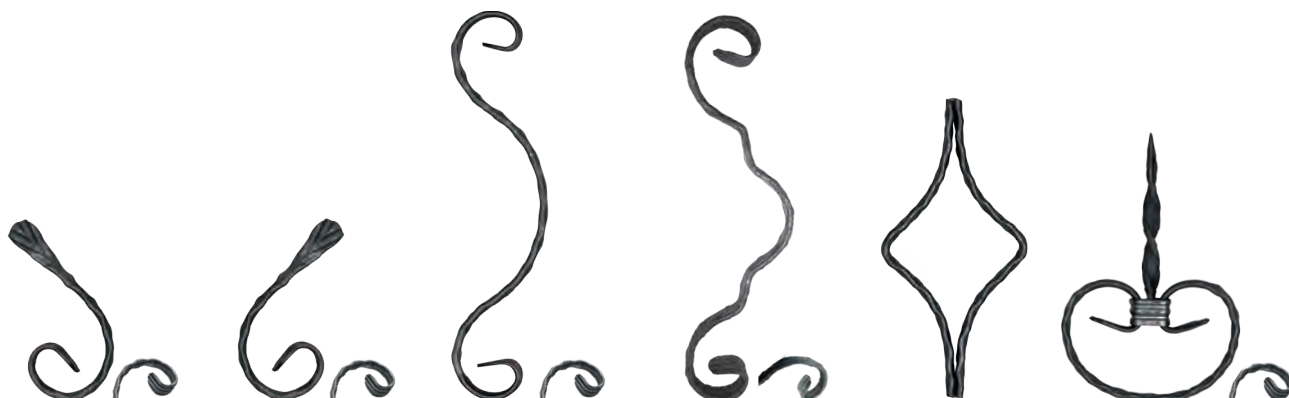

□	12x6	12x6	12x6	12x6	12x6	12x6
H	120	120	260	260	200	180
L	60	60	65	75	100	120
N°	10.215	10.216	10.220	10.221	10.224	10.226



□	12x6	12x6	12x6	12x6
H	100	120	150	150
L	180	220	100	100
N°	10.230	10.231	10.240	10.241



□	12x6	12x6	12x6	12x6
H	190	190	150	150
L	140	140	100	100
N°	10.242	10.243	10.250	10.251

ELEMENTY SPIRALNE

scrolls / спиральные элементы / Spiralemente



□	12x12	12x12	12x12	12x12	12x12	12x12
H	100	120	130	150	190	220
L	70	75	80	82	123	128
N°	10.300	10.301	10.302	10.303	10.304	10.305



□	12x12	12x12	12x12	12x12
H	180	250	260	290
L	88	120	120	120
N°	10.310	10.311	10.312	10.313



ELEMENTY SPIRALNE

scrolls / Spiralelemente / спиральные элементы / spirálové elementy



□	12x12	12x12	12x12
H	200	300	360
L	90	100	120
N°	10.315	10.316	10.317



□	12x12	12x12	12x12
H	125	135	175
L	65	65	95
N°	10.320	10.321	10.323



□	12x12	12x12	12x12
H	280	450	150
L	80	90	80
N°	10.328	10.330	10.340

ELEMENTY SPIRALNE

scrolls / спиральные элементы / Spiralelemente



□	12x6	12x6	12x6	12x6	12x6
H	∅ 110	∅ 100	∅ 120	∅ 100	∅ 120
N°	11.030	11.031	11.032	11.041	11.042

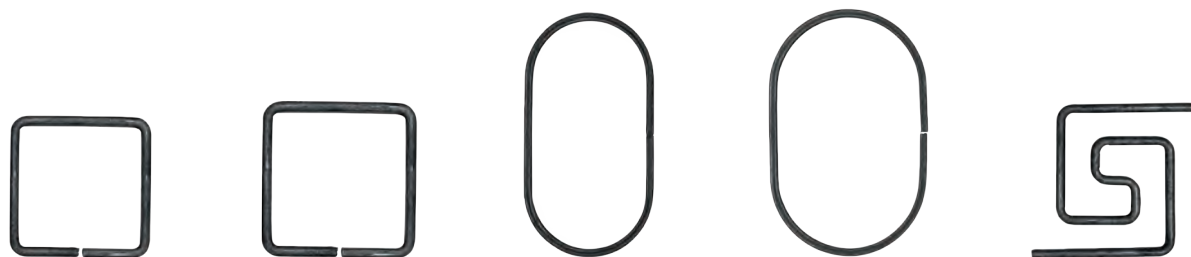

□	12x6	12x6	12x6	12x6	11,5x5,5
H	80	100	190	190	100
L	80	100	100	120	115
N°	11.051	11.052	11.061	11.062	11.091

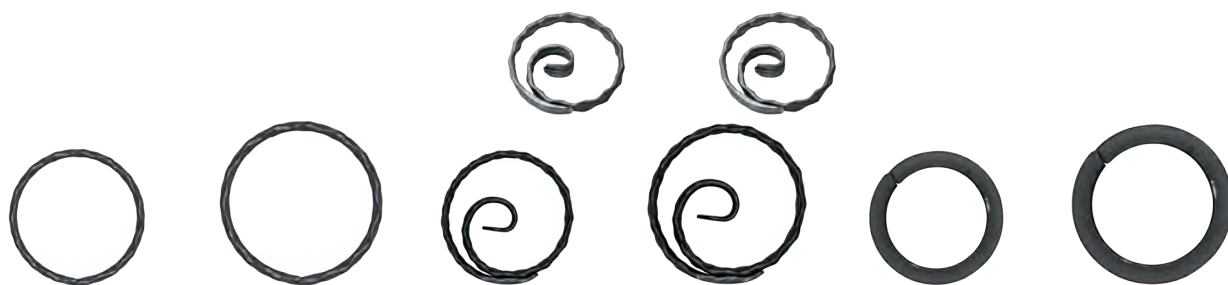

□	12x6	12x6	12x6	12x6	12x12	12x12
H	∅ 100	∅ 120	∅ 100	∅ 120	∅ 100	∅ 120
N°	11.231	11.232	11.241	11.242	11.331	11.332



KOSZYKI

baskets
корзины
Zwirbeln



12.010 - 12.150

POSTAL®

KOSZYKI

baskets / корзины / Zwirbeln



□	6x6
H	70
L	70
N°	12.010



□	12x12
H	130
L	60
N°	12.080



□	14x14
H	130
L	65
N°	12.081



□	16x16
H	145
L	65
N°	12.082



□	20x20
H	165
L	100
N°	12.083



□	24x24
H	180
L	95
N°	12.084



□	12x12
H	130
L	65
N°	12.111



□	12x12
H	150
L	70
N°	12.112



□	12x12
H	190
L	50
N°	12.113

KOSZYKI

baskets / корзины / Zwirbeln



21



□	15x15	18x18	24x24
H	150	190	190
L	75	120	120
N°	12.115	12.118	12.124



□	16x16	16x16	12x12	12x12
H	160	210	200	330
L	85	85	50	63
N°	12.130	12.131	12.148	12.150





ROZETY

rosettes
розетки
Rosetten



13.000 - 13.323

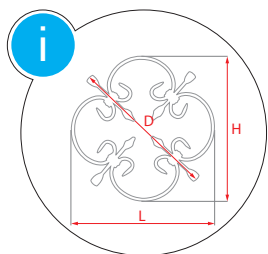

POSTAL®

ROZETY

rosettes / розетки / Rosetten

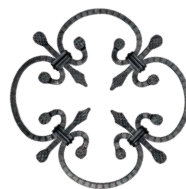
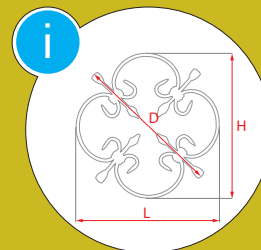

□	12x6	8x8	20x4
H	235	250	250
L	235	250	250
D	280	245	305
N°	13.000	13.003	13.005



□	12x12	12x12
H	375	320
L	300	250
N°	13.006	13.006.01



□	10x5	12x6
H	250	295
L	250	295
D	260	330
N°	13.007	13.008

ROZETY

rosettes / розетки / Rosetten

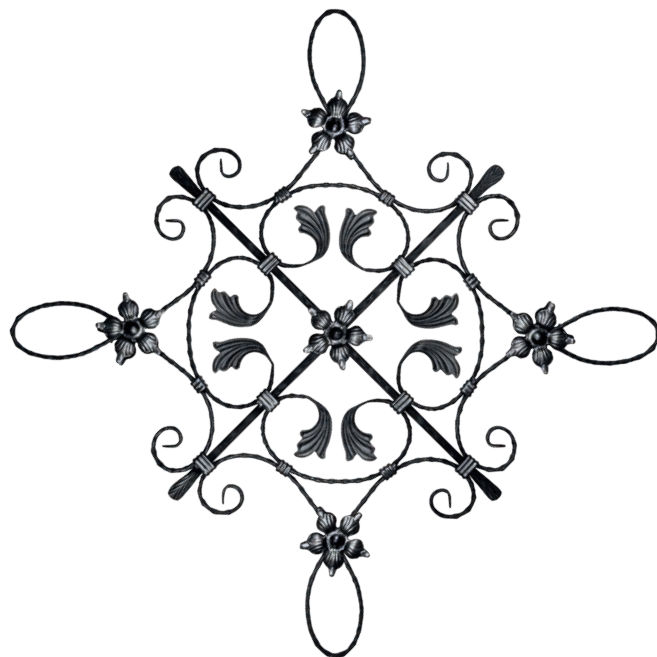

□	12x6	12x6
H	485	880
L	485	880
D	355	640
N°	13.009	13.010

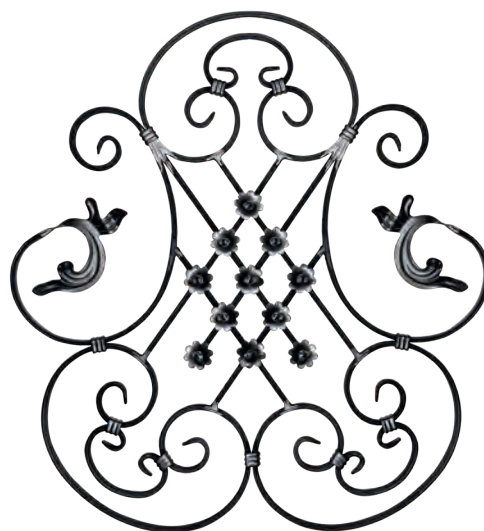
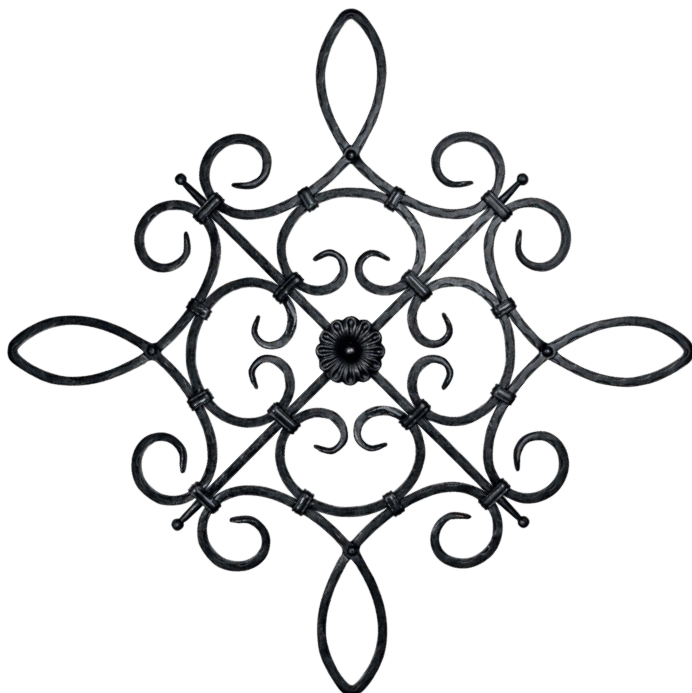

□	12x12	16x8
H	900	700
L	900	650
D	630	
N°	13.011	13.012

ROZETY

rosettes / розетки / Rosetten

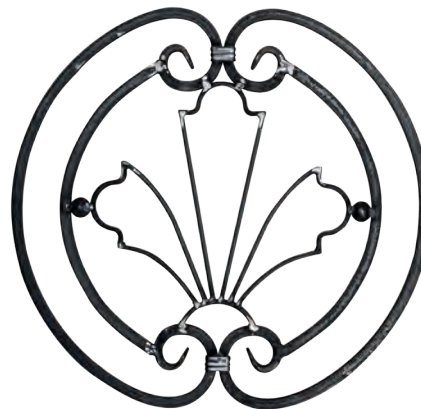
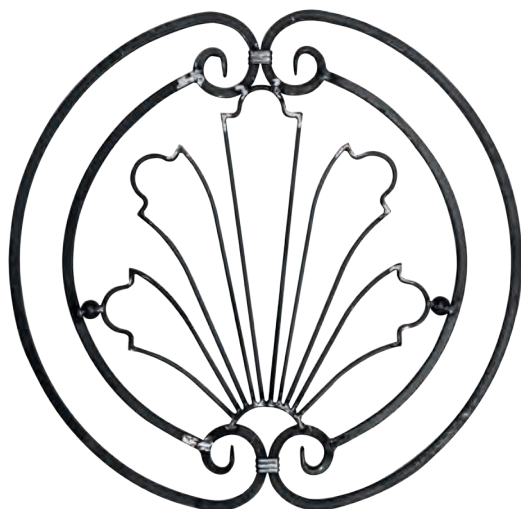
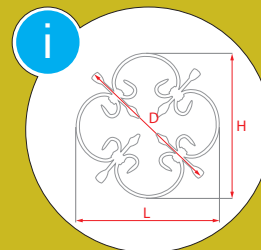

□	14x14
H	680
L	700
N°	13.013

□	14x14
H	540
L	520
N°	13.013.01



□	16x8
H	800
L	450
N°	13.015

□	16x8
H	480
L	410
N°	13.016

□	16x8
H	800
L	440
N°	13.017

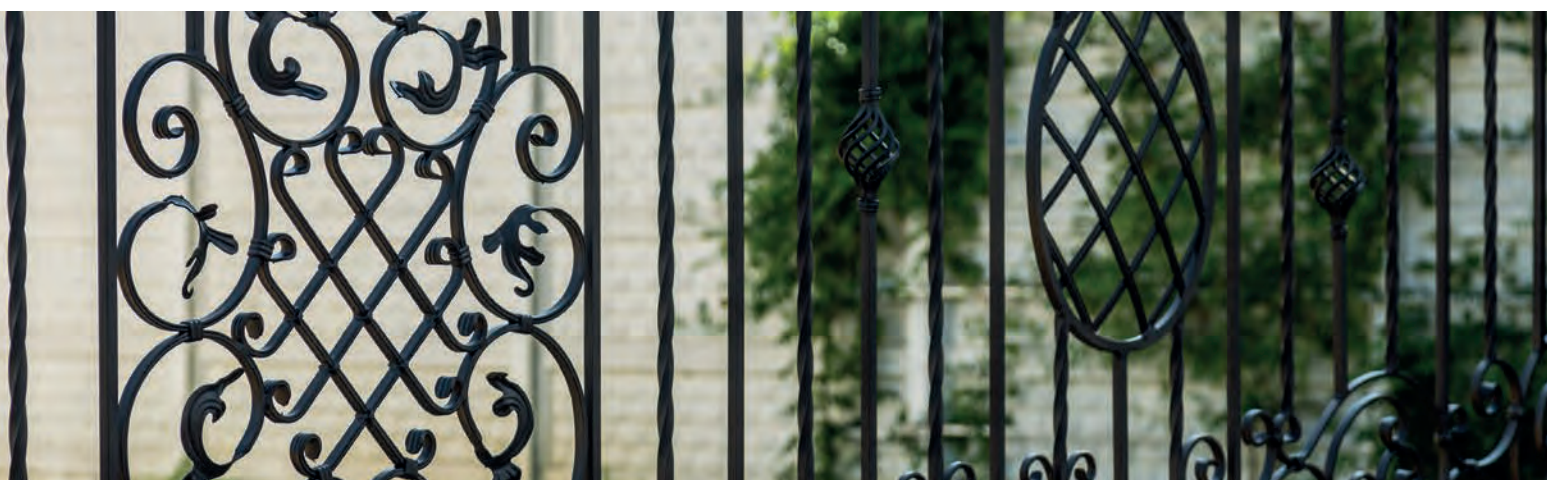

ROZETY

rosettes / розетки / Rosetten



□	12x12	ø13	10x10
H	530	530	530
L	420	420	420
N°	13.018	13.018.01	13.018.02

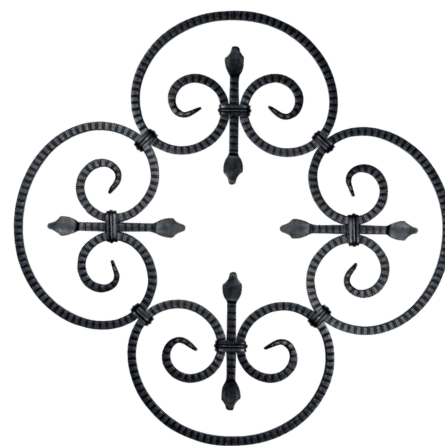
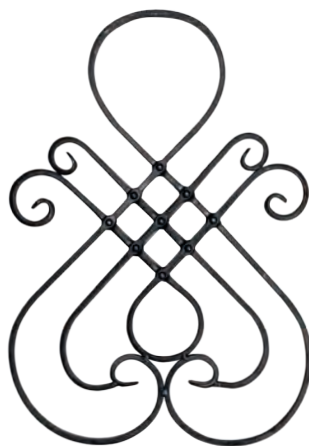
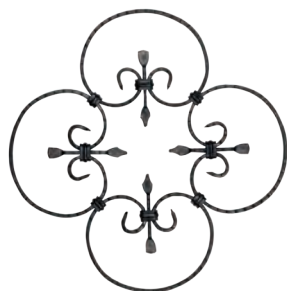

□	10x5	16x8	12x12
H	380	580	590
L	380	400	590
D	325		500
N°	13.020	13.023	13.025



ROZETY

rosettes / розетки / Rosetten

i

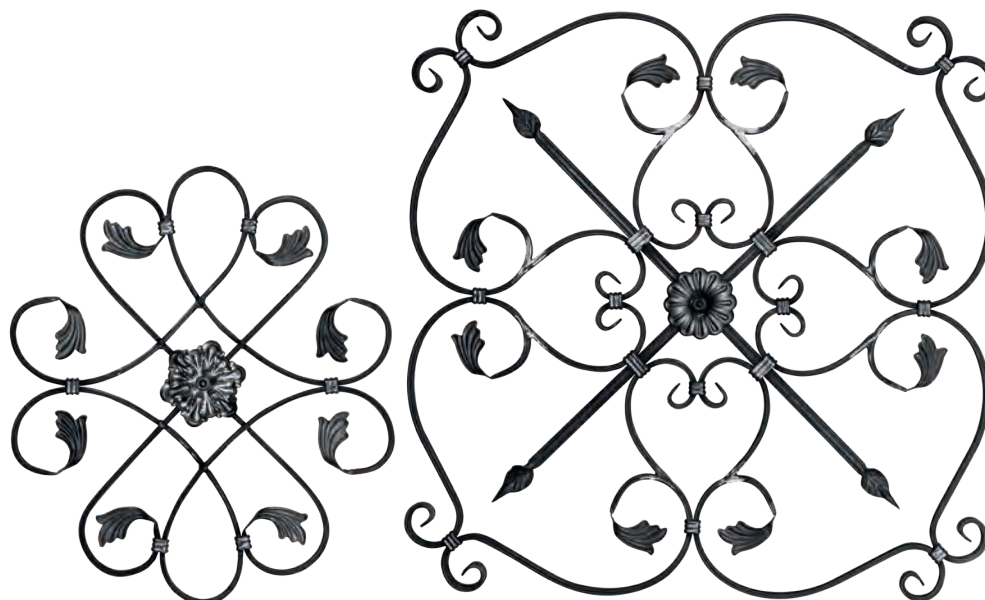
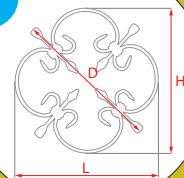

□	16x8	16x8
H	590	800
L	510	800
D		1025
N°	13.026	13.028

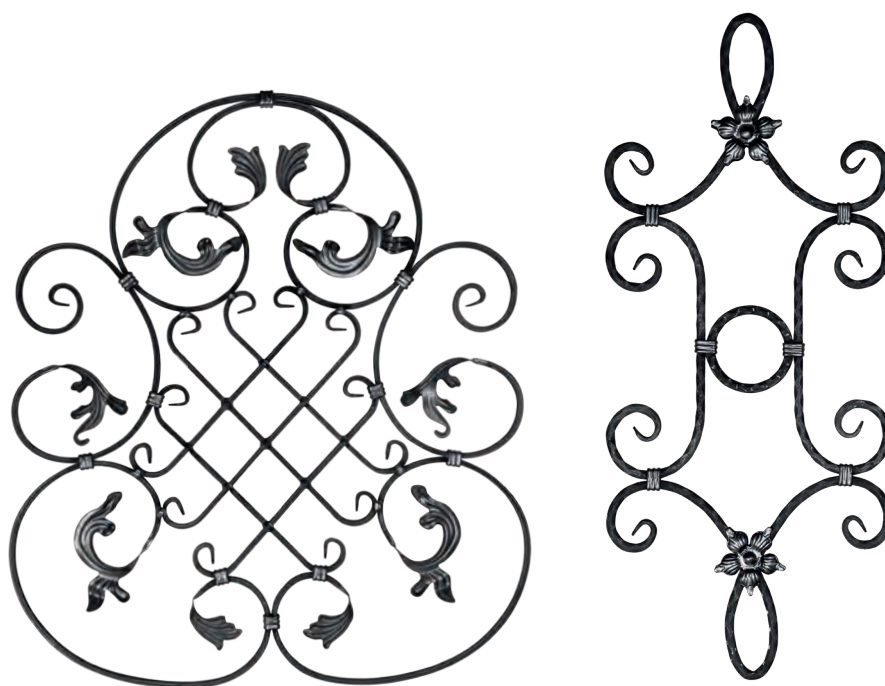

□	16x8	12x12
H	800	900
L	700	385
N°	13.029	13.030

ROZETY

rosettes / розетки / Rosetten



□	12x12	12x12	12x12
H	560	600	510
L	400	370	690
N°	13.032	13.033	13.034



□	12x12	12x12
H	480	450
L	320	340
N°	13.035	13.037



□	12x12	12x12	12x12
H	500	400	400
L	250	350	300
N°	13.038	13.040	13.041

ROZETY

rosettes / розетки / Rosetten

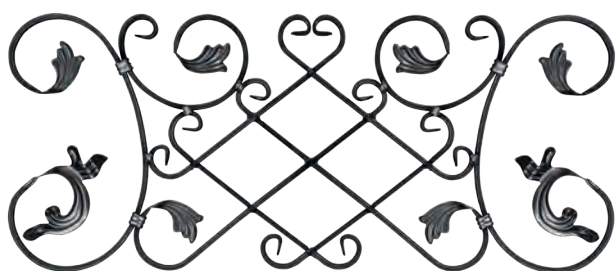
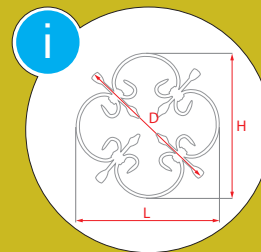

□	16x8	16x8	16x8
H	370	800	800
L	880	300	300
N°	13.042	13.045	13.046

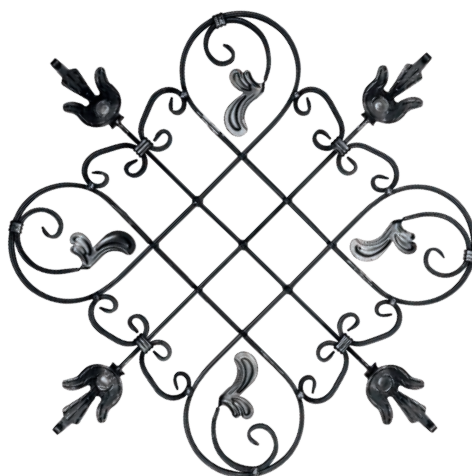

□	16x8	16x8	16x8
H	530	780	800
L	300	780	270
D		870	
N°	13.048	13.056	13.057

ROZETY

rosettes / розетки / Rosetten



□	16x8	16x8	9,5x5	11,5x5,5
H	950	950	410	410
L	190	180	165	165
N°	13.058	13.059	13.060	13.061



□	12x6	12x6
H	230	250
L	700	700
N°	13.067	13.068

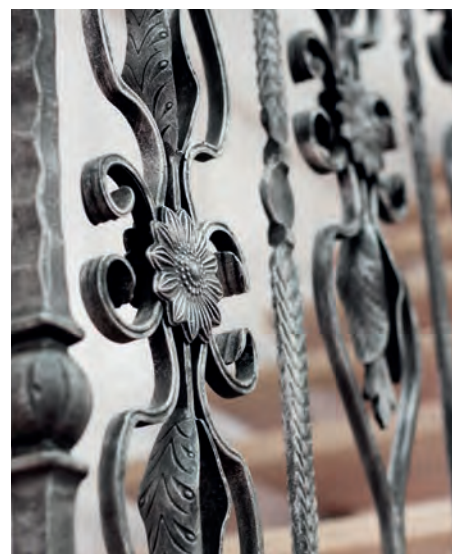

ROZETY

rosettes / розетки / Rosetten

□	12x6
H	250
L	1200
N°	13.070



□	16x8
H	400
L	1510
N°	13.071



□	16x8
H	400
L	1510
N°	13.072



□	16x8
H	330
L	1270
N°	13.073

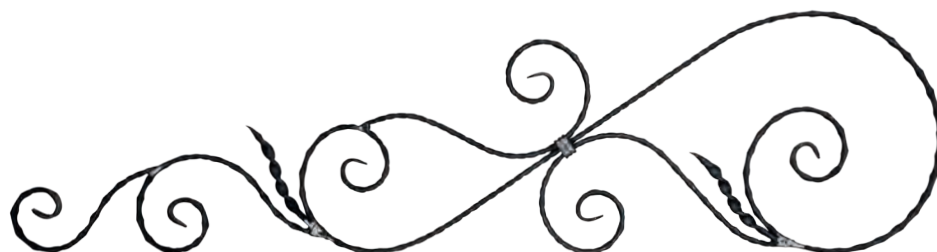

□	16x8
H	330
L	1270
N°	13.074



ROZETY

rosettes / розетки / Rosetten



□	16x8
H	170
L	970
N°	13.090



□	16x8
H	135
L	950
N°	13.091



□	∅12
H	170
L	970
N°	13.092



≠	4
H	100
L	1160
N°	13.093



≠	4
H	100
L	1160
N°	13.094



≠	4
H	90
L	1195
N°	13.096



≠	4
H	120
L	1183
N°	13.097



ROZETY

rosettes / розетки / Rosetten



□	ø11	ø11
H	950	950
L	500	500
N°	13.081	13.082



□	ø12	ø12
H	1080	1080
L	750	750
N°	13.100	13.101

ROZETY

rosettes / розетки / Rosetten



□	ø12	ø12
H	880	880
L	750	750
N°	13.104	13.105



□	ø12	ø12
H	880	880
L	500	500
N°	13.106	13.107

ROZETY

rosettes / розетки / Rosetten



□	16x8	16x8	16x8
H	800	800	740
L	300	300	320
N°	13.111	13.112	13.113



□	16x8	16x8
H	610	400
L	700	800
N°	13.190	13.191

ROZETY

rosettes / розетки / Rosetten

37



□	16x8
H	400
L	1000
N°	13.192

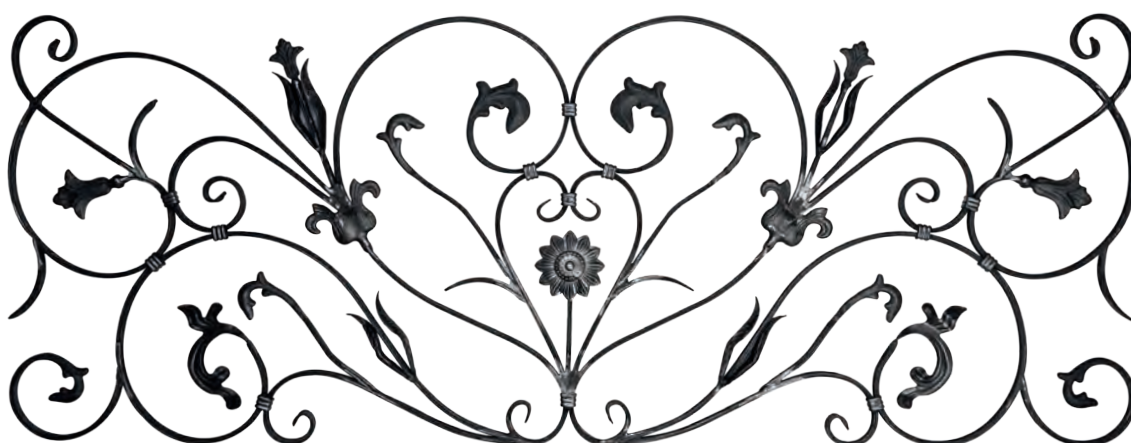

□	16x8
H	600
L	1580
N°	13.198



ROZETY

rosettes / розетки / Rosetten



□	ø16, ø14, ø12
H	800
L	1900
N°	13.200



□	ø14	ø14	ø14
H	800	1000	800
L	160	215	165
N°	13.202	13.203	13.204

ROZETY

rosettes / розетки / Rosetten



□	ø12	ø12	ø12	ø12
H	860	860	430	430
L	950	950	190	190
N°	13.209	13.210	50.175	50.176



ROZETY

rosettes / розетки / Rosetten



□	12x12	12x12	12x12
H	560	490	430
L	400	ø385	ø250
N°	13.241	13.248	13.249



□	12x12	12x12	12x12	12x12
H	ø384	525	415	545
L		ø250	ø385	ø385
N°	13.250	13.251	13.252	13.253



□	12x12	12x12	12x12
H	440	450	500
L	285	380	384
N°	13.256	13.315	13.323

ROZETY

rosettes / розетки / Rosetten





TRALKI I SŁUPY

balusters and baluster posts
бaлясины
Stäbe und Brüstungsposten

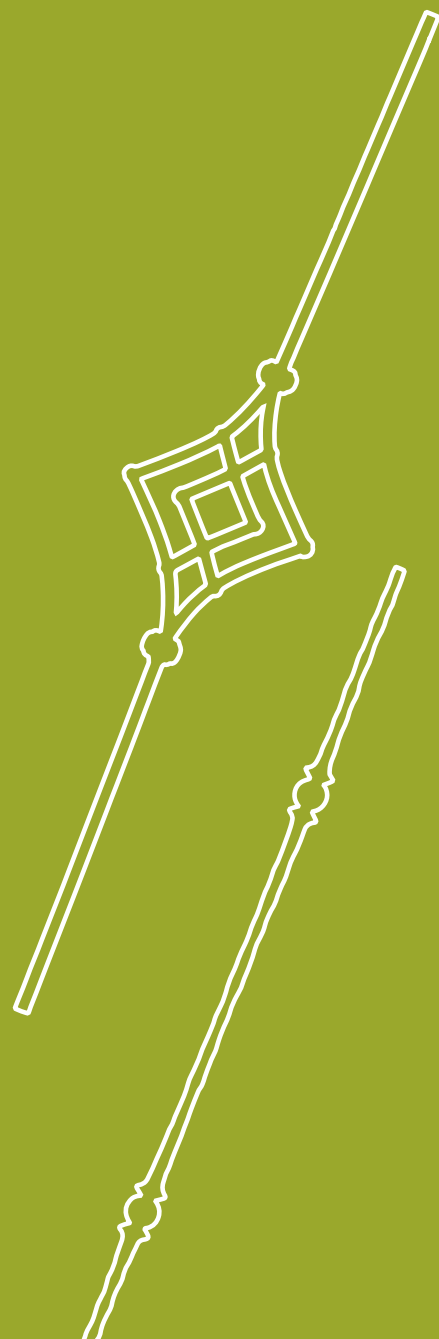

20.001 - 24.266

POSTAL®

TRALKI I SŁUPY

balusters and baluster posts / балясины / Stäbe und Brüstungspfosten



□	12x12
L	160
H	950
N°	20.001



□	12x12
L	175
H	950
N°	20.003



□	12x12
L	200
H	950
N°	20.010



□	12x12
L	200
H	950
N°	20.010.01



□	12x12
L	200
H	950
N°	20.011



□	14x14
L	200
H	950
N°	20.012



□	14x14
L	200
H	950
N°	20.013



□	12x12
L	190
H	950
N°	20.020

TRALKI I SŁUPY

balusters and baluster posts / балясины / Stäbe und Brüstungspfosten



□	12x12	12x12	12x12	30x5
L	200	230	230	170
H	950	950	950	800
N°	20.100	20.102	20.105	20.130



□	50x10	16x16	12x12	12x12
L	185	225	950	950
H	850	950	950	950
N°	20.148	20.149	21.010	21.011



□	12x12	12x12	12x6	12x12
L	950	950	350	90
H	950	950	860	950
N°	21.024	21.025	21.116	21.117





□	16x8
L	155
H	950
N°	21.118

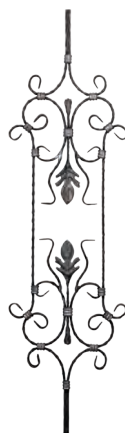

□	12x12
L	270
H	950
N°	21.119



□	12x12
L	170
H	950
N°	21.120



□	16x8
L	165
H	950
N°	21.122



□	12x12
L	240
H	950
N°	21.124



□	12x12
L	200
H	950
N°	21.140



□	12x12
L	275
H	950
N°	21.141



□	12x12
L	195
H	950
N°	21.145



□	12x12
L	200
H	950
N°	21.147

TRALKI I SŁUPY

balusters and baluster posts / балясины / Stäbe und Brüstungspfosten



□	∅30x1,5	∅30x1,5	∅30x1,5
H	900	900	900
N°	21.900	21.901	21.902



□	∅14	∅14	12x12	12x12
L	36	36	30	30
H	950	950	950	950
N°	22.001	22.002	22.003	22.004



□	12x12	12x12	12x12	12x12
L	35	30	36	36
H	950	950	950	950
N°	22.005	22.013	22.019	22.020

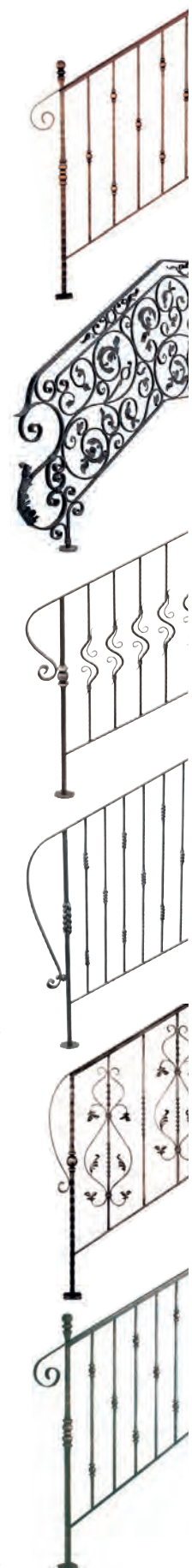

TRALKI I SŁUPY

balusters and baluster posts / балясины / Stäbe und Brüstungspfosten



□	∅12	∅12	∅12
L	30	24	50
H	950	950	1000
N°	22.021	22.022	22.053



□	12x12	12x12	12x12
L	140	185	180
H	950	950	950
N°	22.100	22.103	22.104



□	12x12	12x12
L	180	145
H	950	950
N°	22.105	22.107

TRALKI I SŁUPY

balusters and baluster posts / балясины / Stäbe und Brüstungspfosten

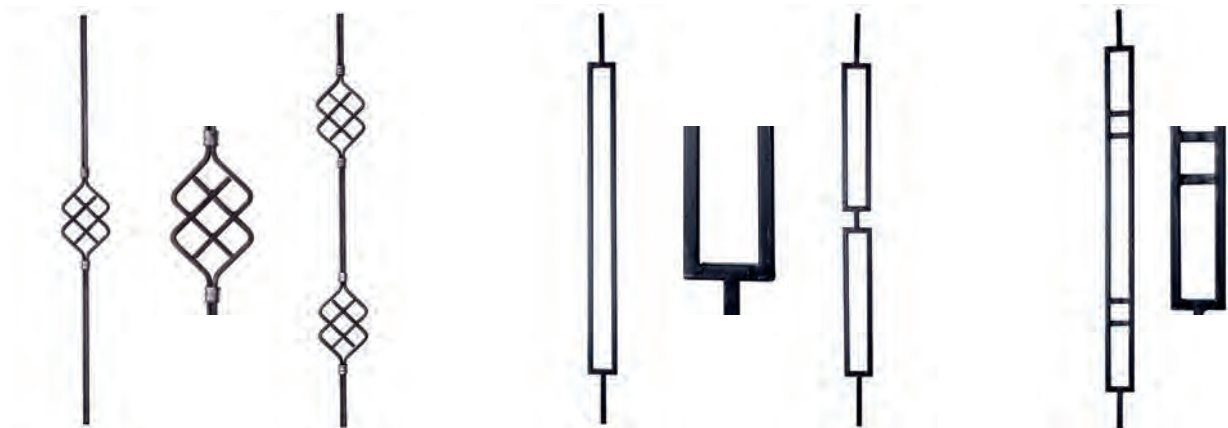

□	12x12	12x12	10x10	10x10	10x10
L	100	100	55	55	55
H	800	800	800	800	800
N°	N 22.150	N 22.151	N 22.200	N 22.201	N 22.203

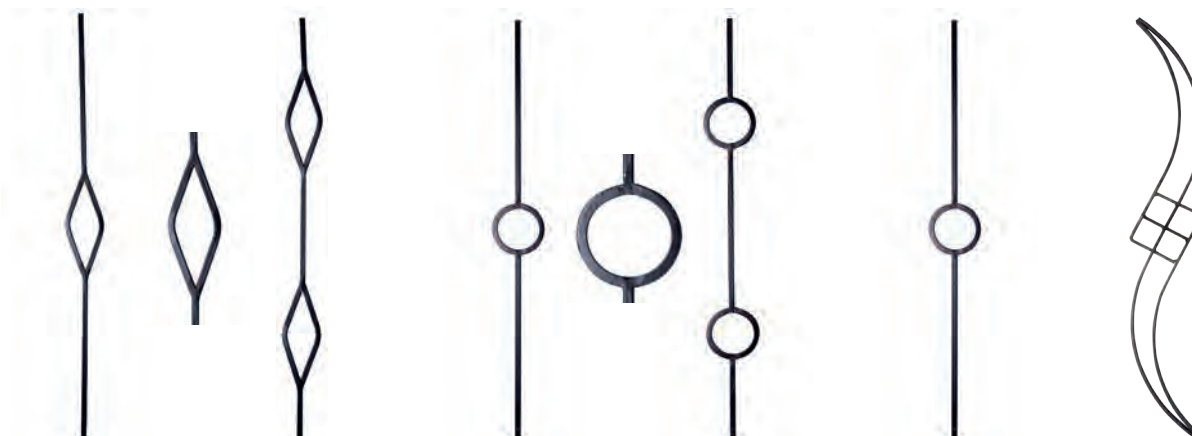

□	10x10	10x10	10x10	10x10	10x10	12x6
L	70	70	100	100	120	120
H	800	800	800	800	800	800
N°	N 22.204	N 22.205	N 22.206	N 22.207	N 22.208	N 22.209

TRALKI I SŁUPY

balusters and baluster posts / балясины / Stäbe und Brüstungspfosten



□	∅12	∅12	14x14	14x14
L	25	25	30	30
H	950	950	950	950
N°	23.001	23.002	23.003	23.004



□	∅12	∅12	12x12	12x12
L	25	25	30	30
H	950	950	950	950
N°	23.005	23.006	23.007	23.008

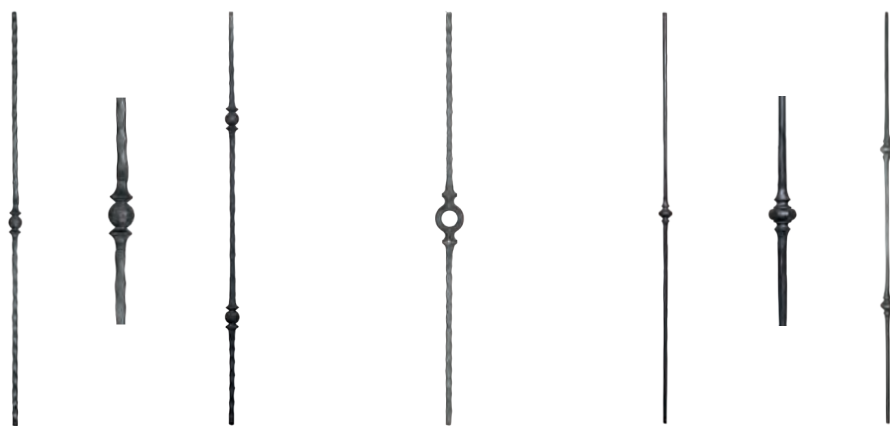

□	14x14	14x14	14x14	∅12	∅12
L	35	35	65	40	40
H	950	950	950	950	950
N°	23.009	23.010	23.015	23.020	23.021



TRALKI | SŁUPY

balusters and baluster posts / балясины / Stäbe und Brüstungspfosten

51



□	14x14	14x14	16x16
L	35	40	60
H	950	950	950
N°	23.024	23.025	23.065



□	12x12	12x12
L	200	200
H	800	800
N°	N 23.030	N 23.031



TRALKI I SŁUPY

balusters and baluster posts / балясины / Stäbe und Brüstungspfosten



□	20x20	∅25	∅28	25x25	25x25
L	80	55	60	100	50
H	1 200	1 200	1 200	1 200	1 200
N°	24.011	24.111	24.112	24.151	24.254



□	25x25	25x25	25x25	25x25
L	34	48	50	66
H	1 200	1 200	1 200	1 200
N°	24.255	24.257	24.259	24.266



TRALKI I SŁUPY

balusters and baluster posts / балясины / Stäbe und Brüstungspfosten





PŁASKOWNIKI I TAŚMY

flat bars and banding materials
полосы и ленты
Stangenmaterial und Hespeneisen

30.001 - 31.404

POSTAL[®]

PŁASKOWNIKI I TAŚMY

flat bars and banding materials / полосы и ленты /
Flacheisen und Hespeneisen



PRODUKT NA ZAMÓWIENIE
for special order /
продукт на заказ /
Produkt auf Bestellung



H	100		180			
L	3000	6000	350	680	300	400
□	40x12	40x12	40x12			40x12
N°	30.001	30.001.00	30.001.01			30.001.04
□	50x14	50x14	50x14	50x14	50x14	
N°	30.002	30.002.00	30.002.01	30.002.02	30.002.03	
□	40x10	40x10	40x10	40x10	40x10	40x10
N°	30.003	30.003.00	30.003.01	30.003.02	30.003.03	30.003.04



PŁASKOWNIKI I TAŚMY

flat bars and banding materials / полосы и ленты / Flacheisen und Hespeneisen

57

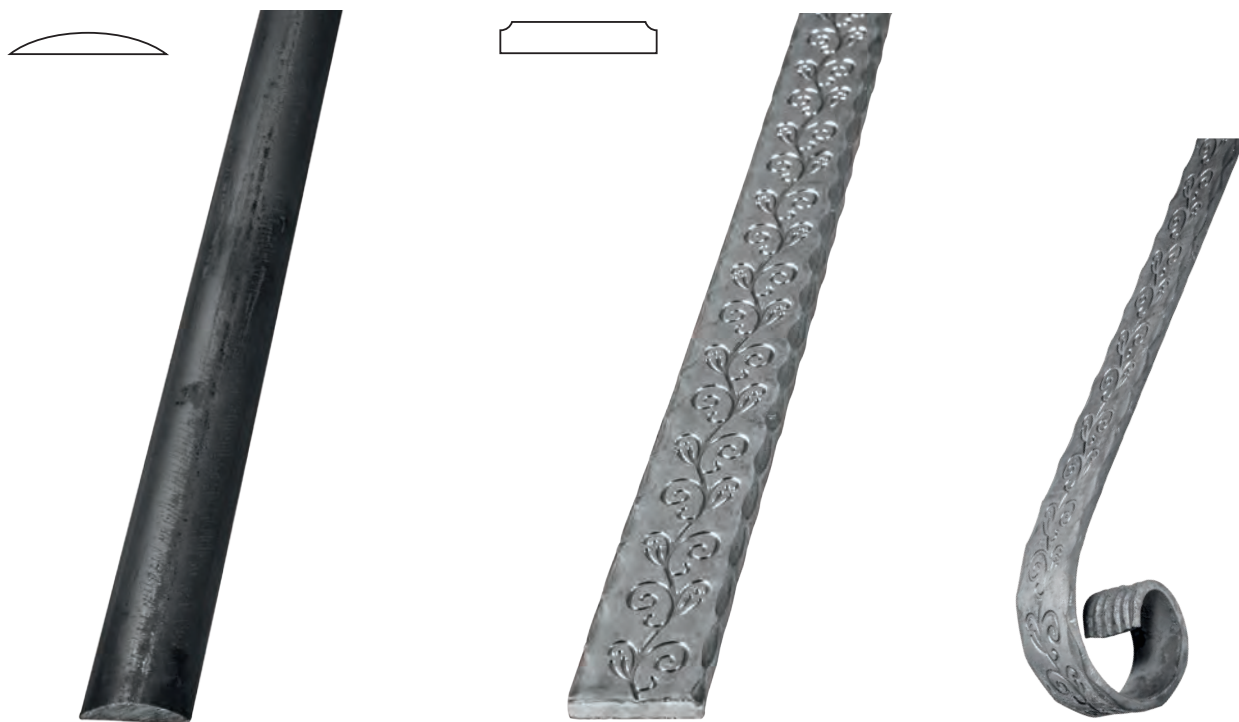

H					100
L	3000	6000	3000	350	
□	40x8	40x8	40x8	40x8	
N°	30.008	30.008.00	30.010	30.010.01	

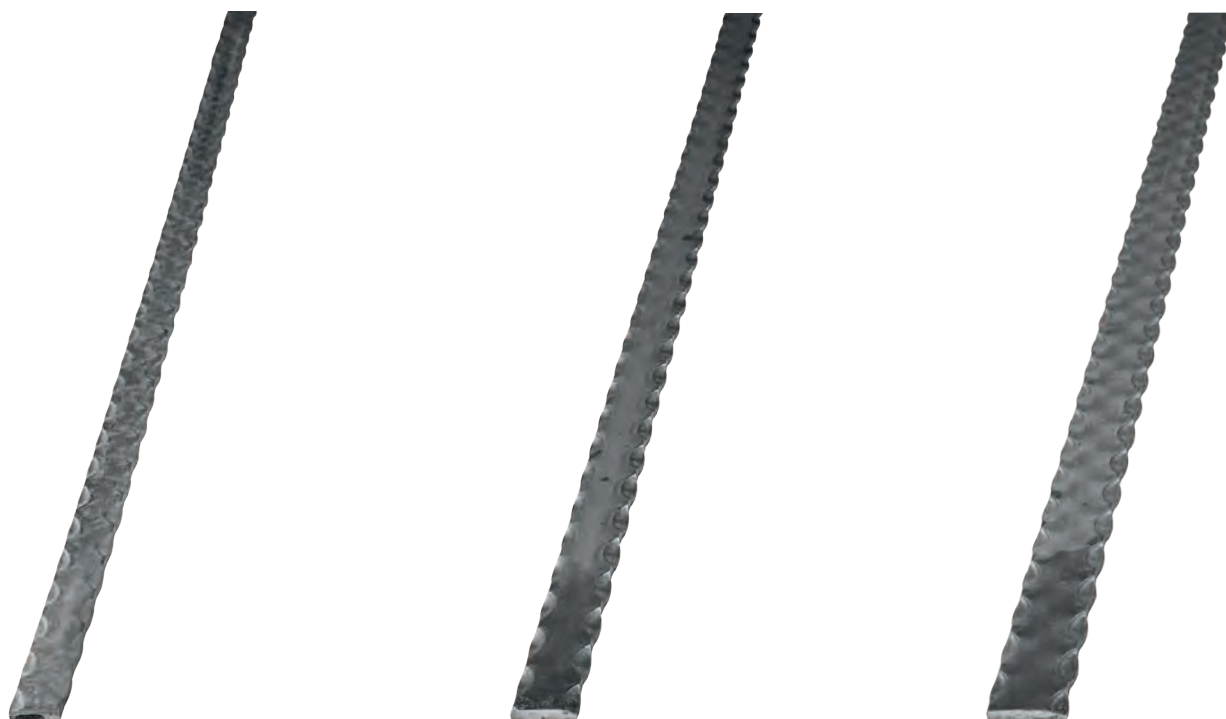

L	3000	3000	6000	3000	6000
□	20x5	25x5	25x5	30x5	30x5
N°	30.100	30.101	30.101.00 ☒	30.102	30.102.00 ☒

PŁASKOWNIKI I TAŚMY

flat bars and banding materials / полосы и ленты /
Stangenmaterial und Hespenseisen



PRODUKT NA ZAMÓWIENIE
for special order /
продукт на заказ /
Produkt auf Bestellung



H				100
L	3000	6000	350	680
□	40x8		40x8	
N°	30.103		30.103.01	
□	40x5	40x5	40x5	40x5
N°	30.105	30.105.00	30.105.01	30.105.02

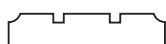

H				100
L	3000	350	400	
□	40x5	40x5	40x5	
N°	30.113	30.113.01	30.113.04	
□	40x8			
N°	30.123			

PŁASKOWNIKI I TAŚMY

flat bars and banding materials / полосы и ленты / Stangenmaterial und Hespeneisen

59



H			100		100
L	3000	6000	350	3000	400
□	40x5	40x5	40x5	40x5	40x5
N°	30.111	30.111.00 ☒	30.111.01	30.114	30.114.01



PŁASKOWNIKI I TAŚMY

flat bars and banding materials / полосы и ленты /
Stangenmaterial und Hespeneisen



PRODUKT NA ZAMÓWIENIE
for special order /
продукт на заказ /
Produkt auf Bestellung



L	3000
□	40x5
N°	30.115
□	40x8
N°	30.125 ☒



L	3000	3000
□	12x6	20x10
N°	30.200	30.202

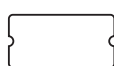

L	3000
□	16x8
N°	30.220

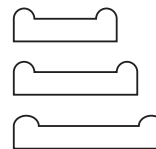

L	3000	6000
□	25x8	25x8
N°	31.101	31.101.00
□	30x8	30x8
N°	31.102	31.102.00
□	40x8	40x8
N°	31.103	31.103.00

PŁASKOWNIKI I TAŚMY

flat bars and banding materials / полосы и ленты / Stangenmaterial und Hespeneisen

61

miękkie

soft and flexible / мягкий и гибкий / weich und flexibel



L	3000	2000	3000	3000	3000	3000
□	14x4	18x1,5	14x3	20x4	14x4	14x4
N°	31.300.01	31.350	31.400	31.402	31.403	31.404

L	1000	1000	1000	1000	1000	1000
□	14x4	18x1,5	14x3	20x4	14x4	14x4
N°	N 31.300.01M1	N 31.350M1	N 31.400M1	N 31.402M1	N 31.403M1	N 31.404M1

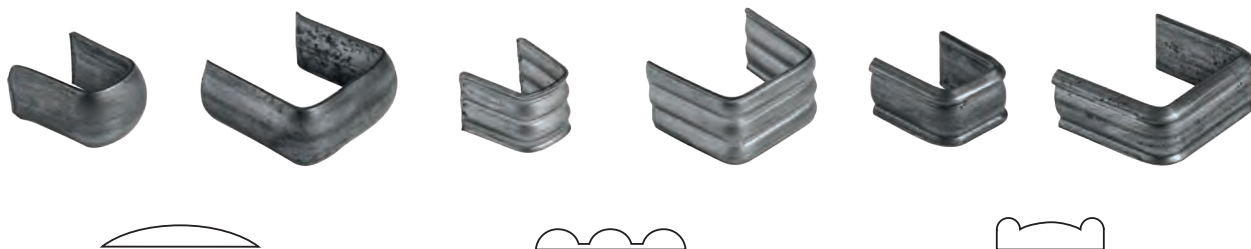

≠	14x4	14x4	18x1,5	18x1,5	14x3	14x3
□	12x12	24x12	12x12	24x12	12x12	24x12
N°	N 31.300.12	N 31.300.24	N 31.350.12	N 31.350.24	N 31.400.12	N 31.400.24

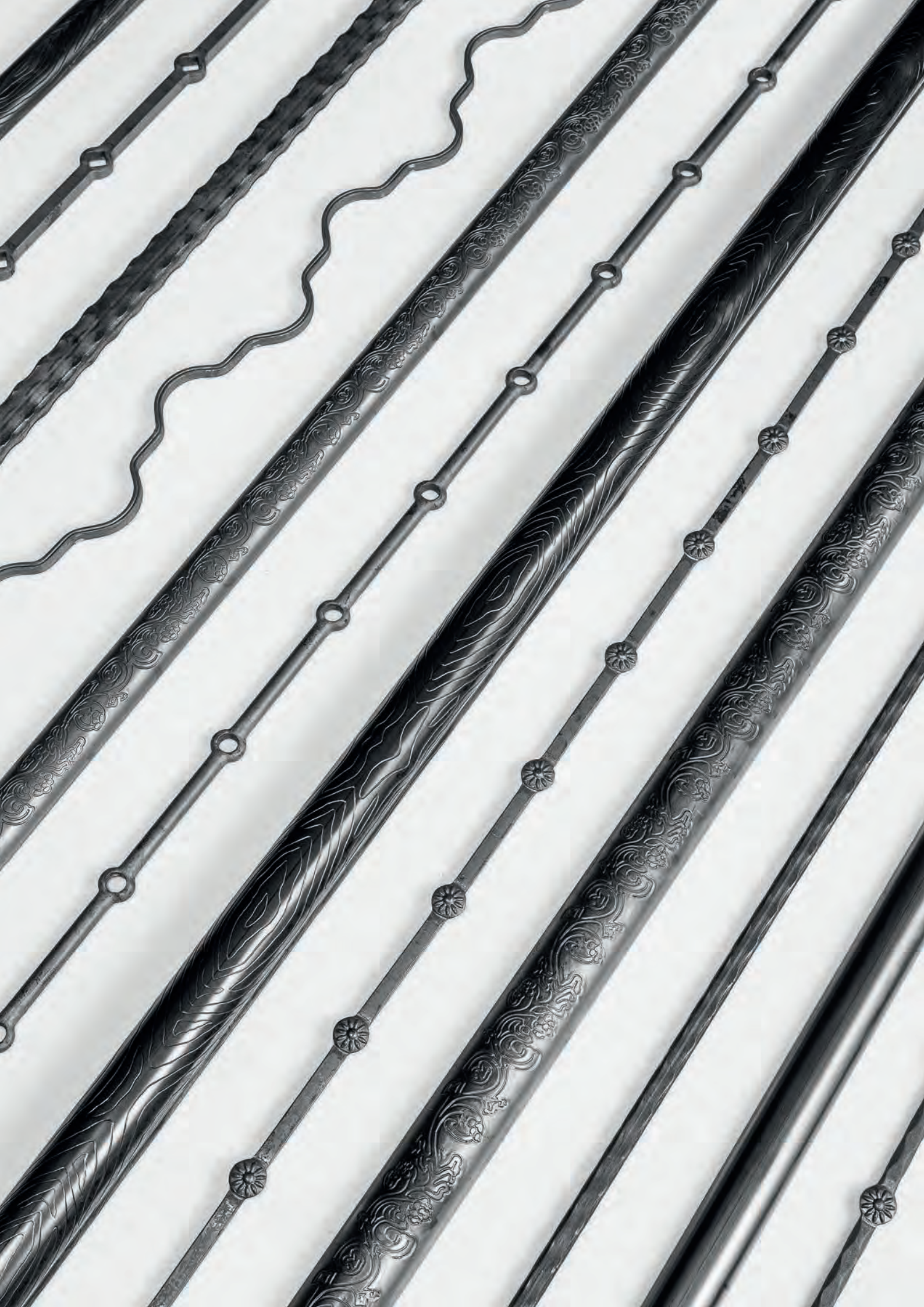

PROFILE ZAMKNIĘTE I PRĘTY OZDOBNE

bars and decorative bars
прутья и декоративные прутья
Vierkantrohre und decorative Stäbe

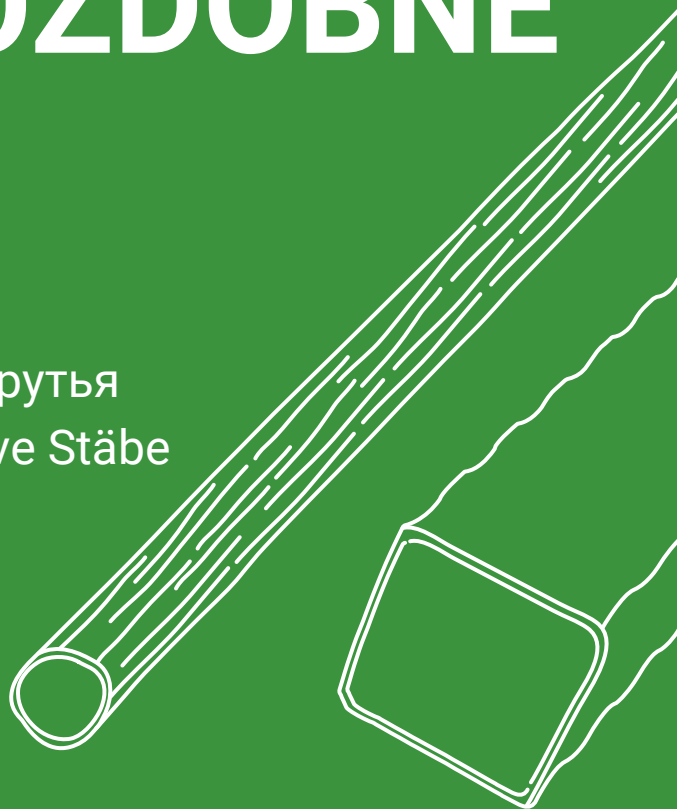

30.020 - 34.231

POSTAL®

PROFILE ZAMKNIĘTE I PRĘTY OZDOBNE

bars and decorative bars / прутья и декоративные прутья /
Vierkantrohre und decorative Stäbe

64



PRODUKT NA ZAMÓWIENIE
for special order /
продукт на заказ /
Produkt auf Bestellung



□	48x20	48x20	48x20	62x30	62x30	60x32
≠	1,5	1,5	1,5	1,5	1,5	1,5
L	3000	3000	3000	3000	3000	3000
N°	30.020	30.020.01	30.020.02	30.021	30.021.01	30.021.02



□	54x54	54x54	54x54	□	48x20	62x30	54x54
≠	1,5	1,5	1,5	H	40	50	36
L	3000	3000	3000	N°	30.030	30.031	30.032
N°	30.022	30.022.01	30.022.02				

PROFILE ZAMKNIĘTE I PRĘTY OZDOBNE

bars and decorative bars / прутья и декоративные прутья /
Vierkantrohre und decorative Stäbe

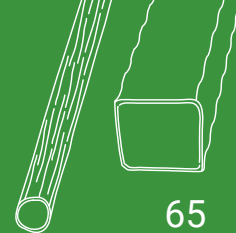

65



□	L	N°
12x12	3000	32.001
12x12	6000	32.001.00
14x14	3000	32.003
14x14	6000	32.003.00 ☒
16x16	3000	32.005
16x16	6000	32.005.00
20x20	3000	32.007



□	L	N°
∅10-12	1100	32.100
∅12-16	1100	32.101

PROFILE ZAMKNIĘTE I PRĘTY OZDOBNE

bars and decorative bars / прутья и декоративные прутья /
Vierkantrohre und decorative Stäbe

66



□	L	N°
∅8	3000	32.111
∅10	3000	32.112
∅12	3000	32.113
∅14	3000	32.114
∅16	3000	32.115
∅20	3000	32.117



□	L	N°
∅25	2750	32.200
∅30	2750	32.201
∅38	2750	32.202

PROFILE ZAMKNIĘTE I PRĘTY OZDOBNE

bars and decorative bars / прутья и декоративные прутья /
Vierkantrohre und decorative Stäbe

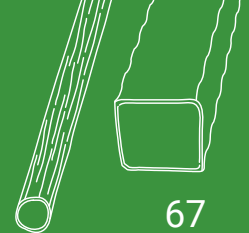

67

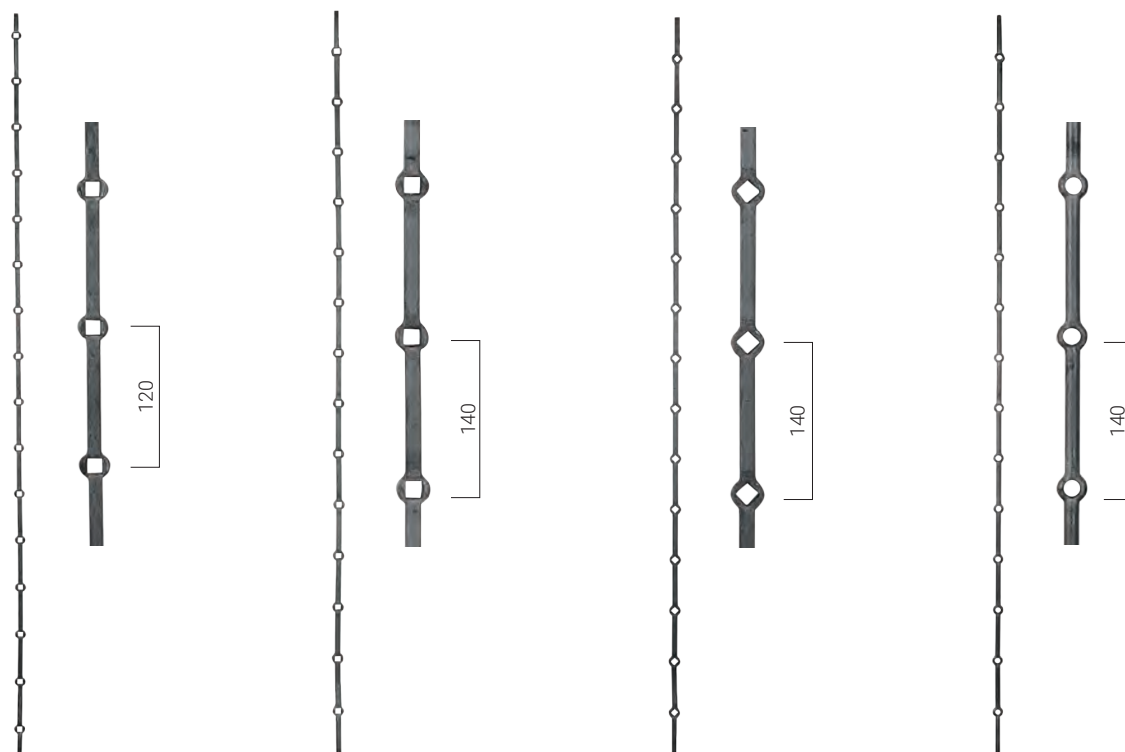

□	12x12	14x14	14x14	∅14
H	2000	2000	2000	2000
N°	33.000	33.001	33.013	33.023

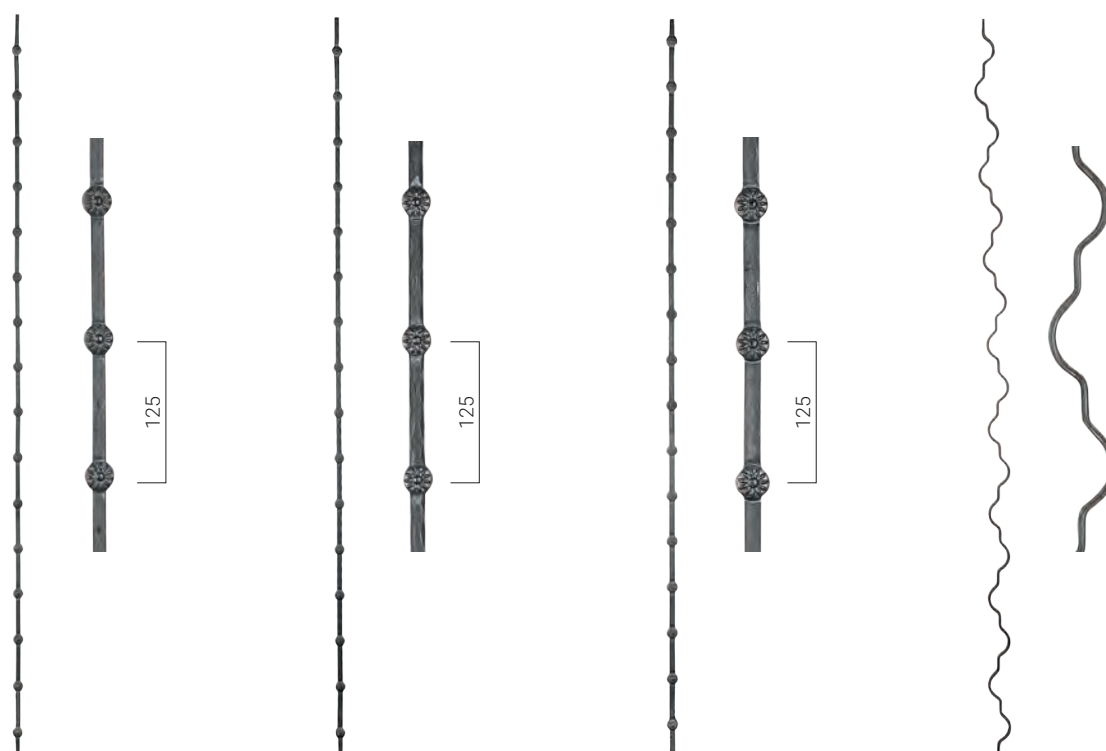

□	12x12	12x12	14x14	12x6
H	2000	2000	2000	2000 x 65
N°	33.098	33.099	33.100	33.201

PROFILE ZAMKNIĘTE I PRĘTY OZDOBNE

bars and decorative bars / прутья и декоративные прутья /
Vierkantrohre und decorative Stäbe



□	≠	L	N°
15x15	1,5	3000	34.000
20x20	2	3000	34.002
20x20	2	6000	34.002.00 ✉
25x25	2	3000	34.005
30x30	2	3000	34.008
30x30	2	6000	34.008.00 ✉
40x40	2	3000	34.011
40x40	2	6000	34.011.00 ✉
50x50	3	3000	34.014
60x60	3	3000	34.017
80x80	3	3000	34.020
80x80	3	6000	34.020.00 ✉
100x100	3	3000	34.023
100x100	3	6000	34.023.00 ✉



PROFILE ZAMKNIĘTE I PRĘTY OZDOBNE

bars and decorative bars / прутья и декоративные прутья /
Vierkantrohre und decorative Stäbe

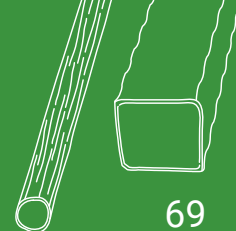

69



□	≠	L	N°
30x20	2	3000	34.102
30x20	2	6000	34.102.00 ☒
40x20	2	3000	34.105
40x20	2	6000	34.105.00 ☒
40x30	2	3000	34.107
40x30	2	6000	34.107.00 ☒
50x30	3	3000	34.111
50x30	3	6000	34.111.00 ☒
60x40	3	3000	34.120
60x40	3	6000	34.120.00 ☒



□	≠	L	N°
∅32	1,2	3000	34.221
∅40	1,2	3000	34.230
∅51	1,2	3000	34.231



GROTY

spearheads

ПИКИ

Spitzen



40.001 - 40.300

POSTAL®

GROTY

spearheads / пики / Spitzen



□	∅15	∅16	∅24	∅25	∅30
H	150	150	160	110	125
L	55	66	63	55	65
N°	40.001	40.002	40.003	40.006	40.007



□	∅18	∅12	∅15	∅14	∅24	∅25
H	110	100	125	140	128	140
L	48	45	55	110	65	70
N°	40.008	40.011	40.012	40.013	40.017	40.018



GROTY

spearheads / пики / Spitzen

73



□	∅13	∅13	∅20	∅16	∅26	∅20
H	125	130	110	76	135	130
L	60	53	60	43	70	70
N°	40.041	40.045	40.048	N 40.048.01	40.049	40.050



□	∅12	∅12	12X12	∅17	∅20	∅25
H	130	130	115	155	80	125
L	60	60	53	70	45	65
N°	40.052	40.052.02	40.052.03	40.053	40.055	40.056



GROTY

spearheads / пики / Spitzen



□	∅20	∅25	∅20	∅16	∅20	∅26
H	120	135	115	82	115	140
L	55	65	58	40	58	70
N°	40.058	40.059	40.060	40.060.01	40.060.02	40.061



□	12x12	14x14	12x12	14x14
H	120	140	150	180
L	42	47	40	43
N°	40.065	40.066	40.067	40.068



GROTY

spearheads / пики / Spitzen

75



□	∅25	∅20	∅25	∅20	∅30
H	125	95	135	98	160
L	40	30	40	33	50
N°	40.071	40.071.01	40.072	40.072.01	40.073



□	∅32	∅25	15X15	15X15	12X12
H	125	110	135	130	120
L	60	50	60	50	43
N°	40.077	40.077.02	40.078	40.078.01	40.078.02



□	∅16	∅16	∅25
H	155	160	125
L	65	65	45
N°	40.080	40.081	40.083

GROTY

spearheads / пики / Spitzen



□	20x20	25x25	20x20	15x15	32x32
H	100	160	125	82	160
L	20	25	30	20	40
N°	40.088.01	40.089	40.092	40.092.01	40.093



□	12x12	∅18	24x24	24x24	∅33	∅30	∅24
H	95	125	60	60	150	120	88
L	27	40	35	30	40	35	28
N°	40.095	40.096	40.097	40.097.30	40.098.01	40.098.02	40.098.03



□	25x25	30x30	40x40	18x21	∅16
H	120	155	200	105	160
L	67	92	117	53	90
N°	40.099.01	40.099.02	40.099.03	40.099.04	40.100

GROTY

spearheads / пики / Spitzen

77



□	ø13	14x14	ø16	15x15	18x18	26x26
H	140	110	160	145	250	290
L	50	50	65	80	80	75
N°	40.102	40.102.01	40.104	40.106	40.110	40.111



□	ø40	ø16	ø29	ø35	12x12	20x20
H	200	120	180	205	90	135
L	100	73	60	65	63	90
N°	40.112	40.112.01	40.117	40.118	40.123	40.125

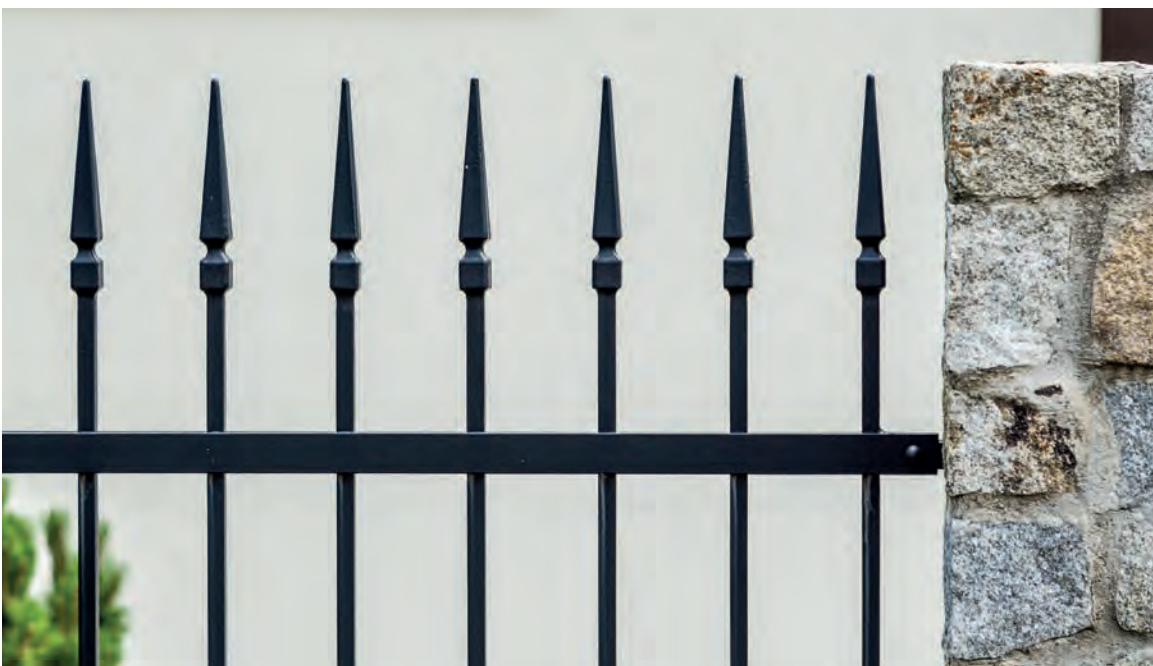

GROTY

spearheads / пики / Spitzen



□	∅33	12x12	16x16	∅12	12x12
H	130	150	57	92	120
L	47	30	38	35	35
N°	40.126	40.133	40.140	40.150	40.151



□	16x16	16x16	20x20	∅16	∅26	36
H	107	142	148	132	134	145
L	25	28	35	85	64	36
N°	40.153	40.154	40.155	40.156	40.157	40.159



GROTY

spearheads / пики / Spitzen



79



□	16x16	12x12	16x16	12x12
H	105	200	155	160
L	60		60	50
N°	40.162	40.170	40.182	40.183



□	∅22	8x16	15x15	18x18	
H	80	90	82	110	165
L	22	55	15	18	70
N°	40.200	N 40.202	40.210	40.211	40.300





PRZEKUWKI

ornamental steel collars

насадки

Zierhülsen

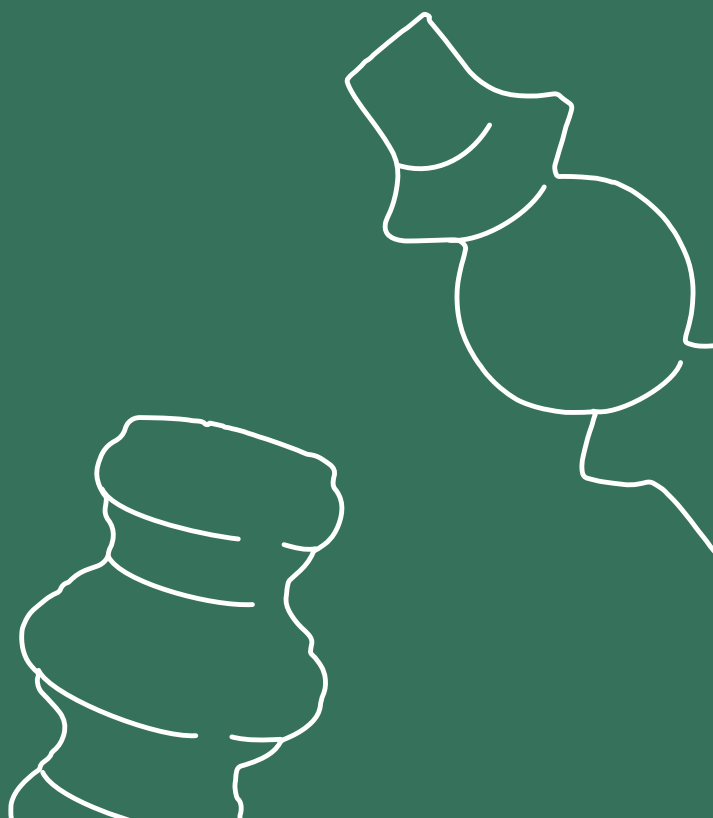

41.001 - 41.506

POSTAL®

PRZEKUWKI

ornamental steel collars/ насадки / Zierhülsen



□	12,5x12,5	12,5x12,5	
H	39	67	67
L	40	40	40
N°	41.001	41.002	41.002.01



□	14,5x14,5	14,5x14,5	∅14,5	∅14,5
H	44	67	40	67
L	45	45	39	40
N°	41.003	41.004	41.005	41.006



□	16,5x16,5	16,5x16,5	∅16,5	∅16,5
H	44	67	44	67
L	45	45	45	45
N°	41.007	41.008	41.011	41.012

PRZEKUWKI

ornamental steel collars/ насадки / Zierhülsen

83



□	12,5x12,5	12,5x12,5	14,5x14,5	14,5x14,5	16,5x16,5	16,5x16,5
H	40	65	40	65	40	65
L	38	38	38	38	38	38
N°	41.021	41.022	41.023	41.024	41.025	41.026



□	ø35,5	30,5 x 30,5	27x27
H	80	80	215
L	69	69	63
N°	41.050	41.060	41.070

PRZEKUWKI

ornamental steel collars/ насадки / Zierhülsen



□	12,5x12,5	14,5x 14,5	16,5x16,5	21,5x21,5	∅13	∅14,5	∅16,5
H	22	22	22	25	25	22	22
L	40	40	40	45	35	40	40
N°	41.102	41.104	41.105	41.106	41.111	41.114	41.115



□	12,5x12,5	14,5x14,5	16,5x16,5	20,5x20,5	25,5x25,5
H	22	22	22	35	35
L	33	38	38	55	55
N°	41.202	41.204	41.205	41.206	41.207

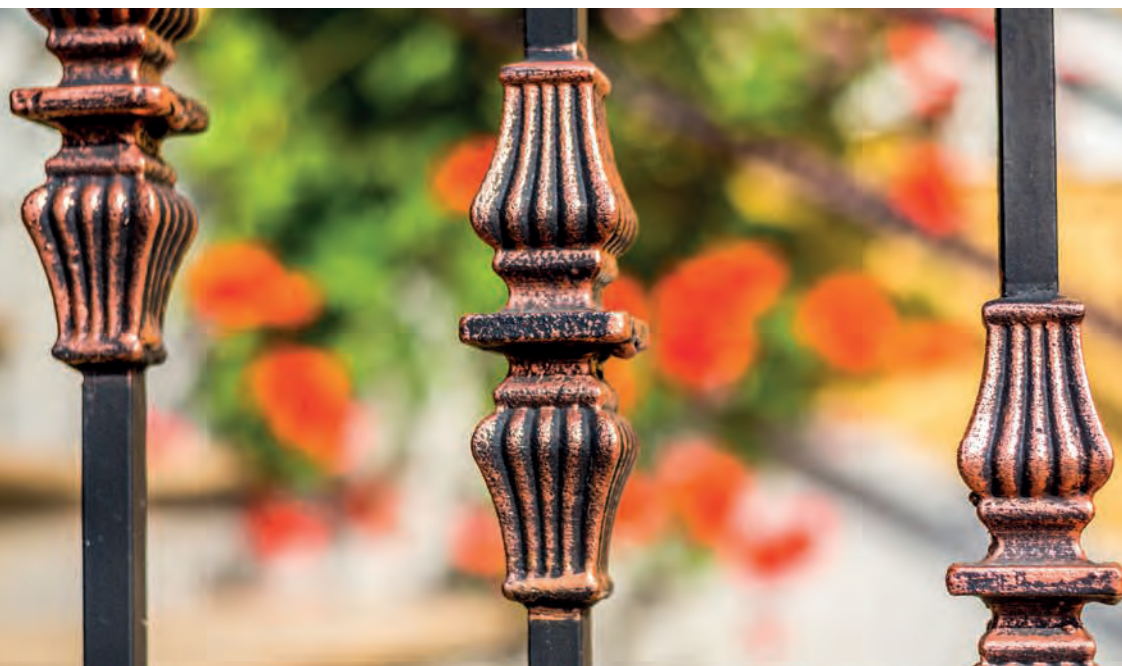

PRZEKUWKI

ornamental steel collars/ насадки / Zierhülsen



85



□	14,5x14,5	14,5x14,5
H	70	130
L	35	35
N°	41.306	41.307



□	16x16	16x16
H	75	148
L	42	48
N°	41.315	41.316



□	∅16	∅16
H	75	125
L	38	38
N°	41.317	41.318



PRZEKUWKI

ornamental steel collars/ насадки / Zierhülsen



□	∅12	12x12	12x12
H	140	140	160
L	28	26	25
N°	41.400	41.401	41.402



□	14x14	12 - 14	16 - 20	20 - 30
H	80	70	75	150
L	35	30	35	35
N°	41.403	41.407	41.408	41.409

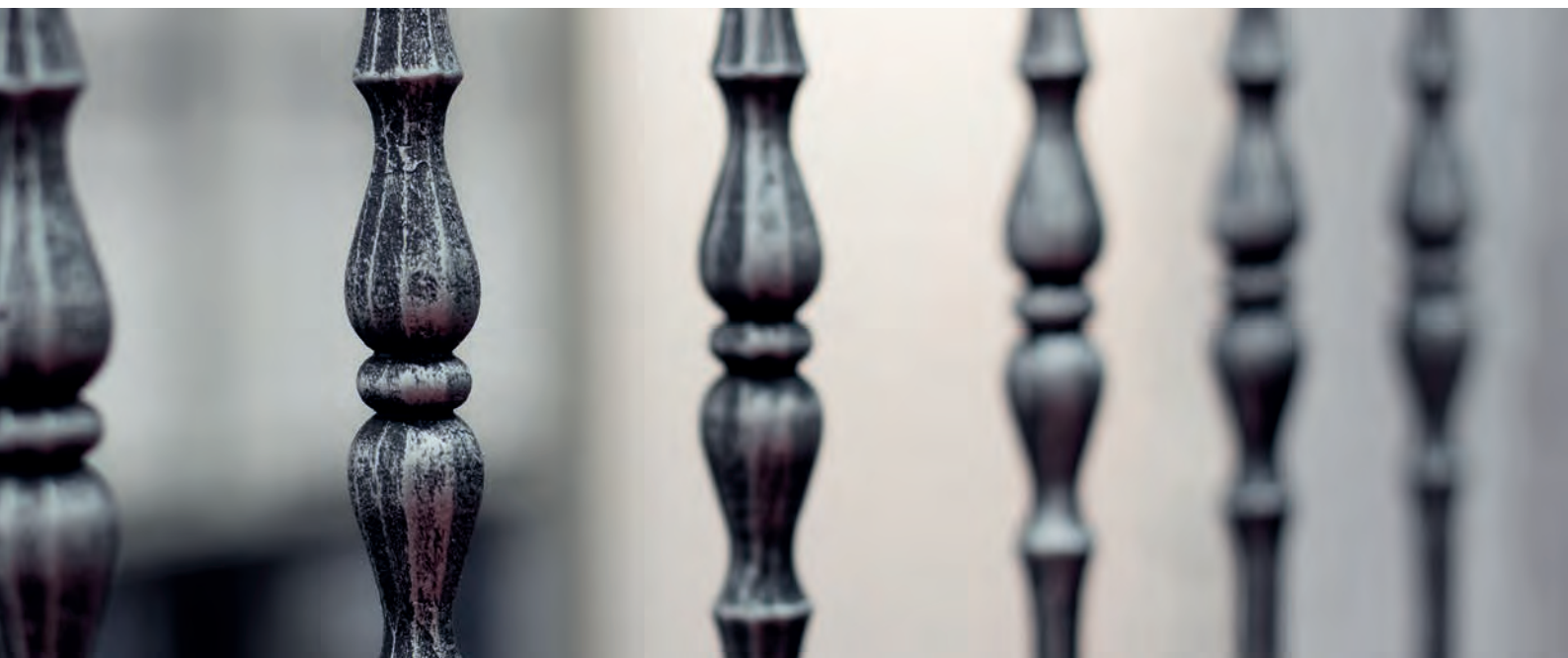

PRZEKUWKI

ornamental steel collars/ насадки / Zierhülsen

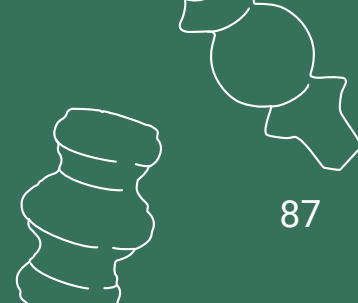

87

cienkościenne
thin-walled / тонкостенные / dünnwandig



□	12,5x12,5	12,5x12,5
H	39	67
L	40	40
N°	41.501	41.502

cienkościenne
thin-walled / тонкостенные / dünnwandig



□	14,5x14,5	14,5x14,5
H	40	67
L	45	45
N°	41.503	41.504

cienkościenne
thin-walled / тонкостенные / dünnwandig



□	∅14,5	∅14,5
H	39	67
L	40	40
N°	41.505	41.506





GAŁKI I KULE

knobs and spheres
верхушки и шары
Pfostenaufsätze und Kugeln



42.000 - 43.800.01

POSTAL®

GAŁKI I KULE

knobs and spheres / верхушки и шары / Pfostenaufsätze und Kugeln



□	ø28
H	80
N°	42.000



□	ø40
H	90
N°	42.001



□	ø50
H	90
N°	42.003



□	25x25
H	60
N°	42.004



□	40x40
H	85
N°	42.005



□	60x60
H	125
N°	42.005.01



□	ø27
H	60
N°	42.006



□	ø42
H	85
N°	42.007



□	ø48
H	125
N°	42.008

GĄŁKI I KULE

knobs and spheres / верхушки и шары / Pfostenaufsätze und Kugeln



□	ø30	ø45	ø55	
H	42	50	70	200x220
N°	42.011	42.012	42.013	42.030



GAŁKI I KULE

knobs and spheres / верхушки и шары / Pfostenaufsätze und Kugeln

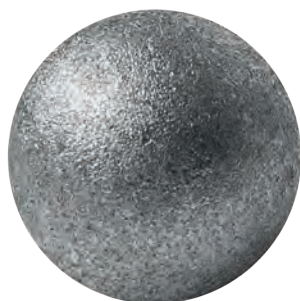
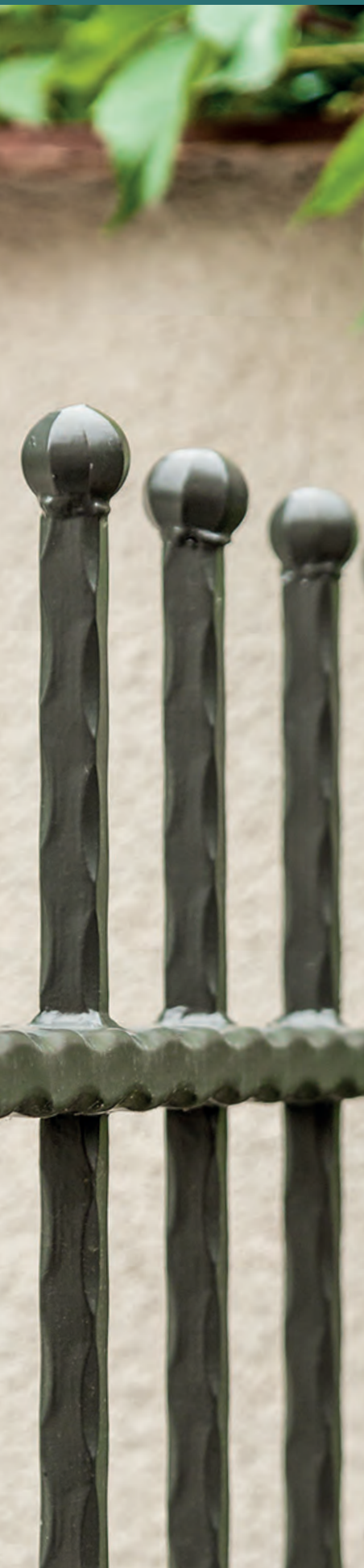

□	N°
∅15	43.015
∅20	43.020
∅25	43.025
∅30	43.030
∅35	43.035
∅40	43.040
∅50	43.050



□	N°
∅20	43.120
∅25	43.125
∅30	43.130
∅35	43.135
∅40	43.140
∅50	43.150



□	N°
∅30	43.230
∅40	43.240
∅50	43.250



≠	□	N°
1	∅40	N 43.504
1	∅50	43.505
1	∅60	43.506
1	∅70	43.507
1	∅80	43.508
1	∅100	43.510
1	∅120	43.512
1	∅150	43.515

GĄŁKI I KULE

knobs and spheres / верхушки и шары / Pfostenaufsätze und Kugeln

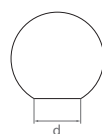

□	d	N°
ø15	8x8	43.615
ø20	10x10	43.620
ø25	14x14	43.625
ø30	14x14	43.630
ø35	16x16	43.635

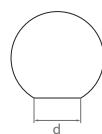

□	d	N°
ø40	ø20	43.640
ø50	ø25	43.650
ø60	ø30	43.660
ø70	ø35	43.670
ø80	ø40	43.680
ø90	ø45	43.690
ø100	ø53	43.700
ø120	ø61	43.720
ø150	ø80	43.750

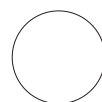

□	N°
ø60	43.660.01
ø80	43.680.01
ø100	43.700.01
ø120	43.720.01
ø200	43.800.01





MASKOWNICE

masking frames
маскировочные элементы
Abschlußrosetten

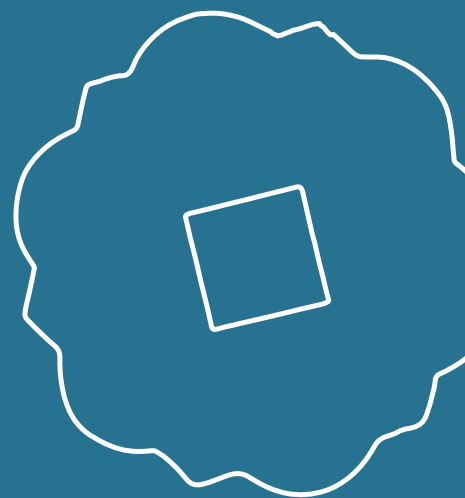

44.001 - 44.259.ZN

POSTAL[®]

MASKOWNICE

masking frames / маскировочные элементы / Abschlußrosetten

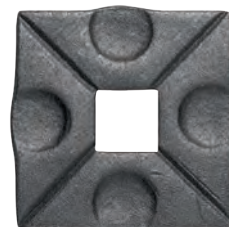

≠	6	6	8
□	12x12	21x21	26x26
H	50	70	90
L	50	70	90
N°	44.001	44.004	44.006



≠	4	10	10
□			31x31
H	80	100	100
L	80	100	100
N°	44.010	44.011	44.013



≠	4	4	4
□		13x13	
H	78	78	100
L	78	78	100
N°	44.017	44.018	44.020

MASKOWNICE

masking frames / маскировочные элементы / Abschlußrosetten

97



≠	4	4	4	4
□				26x26
H	∅67	∅95	∅108	∅105
N°	44.026	44.029	44.034	44.036



≠	8	8	4	2
H	85	120	60	76
L	85	120	60	76
N°	44.038	44.039	44.040	44.043



MASKOWNICE

masking frames / маскировочные элементы / Abschlußrosetten



□	H	L	N°
12,5x12,5/3	12	50x50	44.046
14,5x14,5/3	13	50x50	44.047
16,5x16,5/3	13	50x50	44.048
20,5x20,5/4	17	80x80	44.049
25,5x25,5/4	17	80x80	44.050
30,5x30,5/4	16	80x80	44.051
40,5x40,5/4	17	80x80	44.052



□	H	L	N°
40,5x20,5/4	17	80x80	44.053
30,5x40,5/3	17	80x80	44.054



□	H	L	N°
30,5x30,5	20	80x80	44.119
40,5x40,5	20	80x80	44.121
25,5x25,5	20	60x60	44.122
30,5x30,5	20	60x60	44.123
20,5x20,5	20	50x50	44.126
12,5x12,5	15	40x40	44.127
14,5x14,5	15	40x40	44.128
16,5x16,5	15	40x40	44.129



MASKOWNICE

masking frames / маскировочные элементы / Abschlußrosetten



99



H	L	N°
20	ø60	44.134
20	ø40	44.136



□	H	L	N°
ø12,5	15	ø50	44.138
ø14	15	ø50	44.139
ø25	25	ø80	44.140
ø32	25	ø80	44.141
ø38	30	ø97	44.142
ø42	30	ø97	44.143
ø48	30	ø97	44.144
ø51	30	ø110	44.145



□	H	L	N°
12x12	19	44x44	44.146
12x12	19	44x44	44.146.ZN
14x14	19	44x44	44.147
14x14	19	44x44	44.147.ZN
16x16	19	44x44	44.148
16x16	19	44x44	44.148.ZN
20x20	18	58x58	44.149
20x20	18	58x58	44.149.ZN
25x25	30	80x80	44.150
25x25	30	80x80	44.150.ZN
30x30	30	80x80	44.151
30x30	30	80x80	44.151.ZN
40x40	30	90x90	44.152
40x40	30	90x90	44.152.ZN
50x50	30	100x100	44.153
60x60	28	109x109	44.154
80x80	28	120x120	44.155
80x80	28	120x120	44.155.ZN
100x100	28	140x140	44.156

MASKOWNICE

masking frames / маскировочные элементы / Abschlußrosetten



□	H	L	N°
40x30	30	75x85	44.157
40x60	28	90x110	44.158
20x40	28	100x100	44.159



□	≠	L	N°
12x12	1	40x40	44.230.ZN
14x14	1	40x40	44.231.ZN
16x16	1	40x40	44.232.ZN
20x20	1	40x40	44.233.ZN
12x12	1	50x50	44.234.ZN
14x14	1	50x50	44.235.ZN
16x16	1	50x50	44.236.ZN
20x20	1	50x50	44.237.ZN
20x20	1	50x50	44.238.ZN
20x20	1	60x60	44.239.ZN
30x30	1	60x60	44.240.ZN
40x40	1	60x60	44.241.ZN
50x50	1	60x60	44.242.ZN
20x20	1	70x70	44.243.ZN
30x30	1	70x70	44.244.ZN
50x50	1	70x70	44.246.ZN
20x20	1	80x80	44.247.ZN
30x30	1	80x80	44.248.ZN
40x40	1	80x80	44.249.ZN
20x20	1	100x100	44.251.ZN
30x30	1	100x100	44.252.ZN
50x50	1	100x100	44.254.ZN
20x20	1	120x120	44.256.ZN
30x30	1	120x120	44.257.ZN
40x40	1	120x120	44.258.ZN
50x50	1	120x120	44.259.ZN

MASKOWNICE

masking frames / маскировочные элементы / Abschlußrosetten

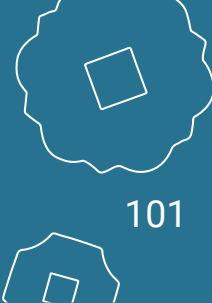

101



#	4	4	6	3	3
□	14,5x14,5				
L		70	105	102	30
H	∅90	155	160	160	135
N°	44.060	44.200	44.205	44.206	44.220



#	4	4	4	5
L	50	60	85	110
H	120	145	200	250
N°	44.201	44.202	44.203	44.204



KWIATY I LIŚCIE

flowers and leaves
ЦВЕТЫ И ЛИСТЬЯ
Blumen und Blätter

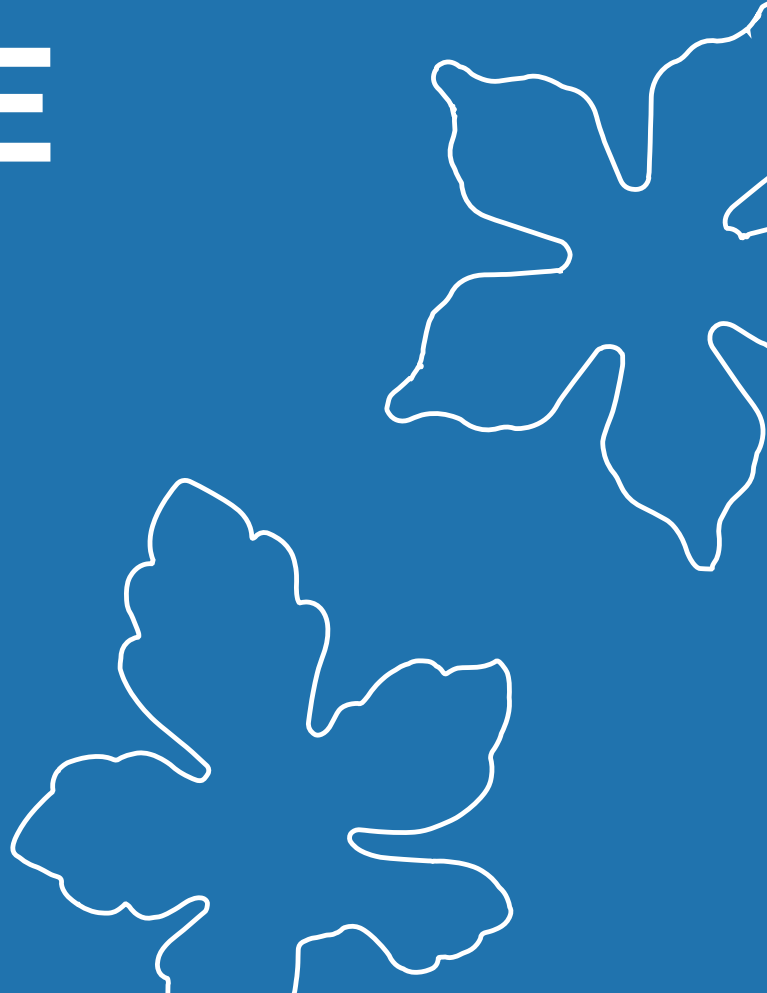

50.000 - 51.452

POSTAL[®]



≠	1,2	5	5	4	2	2
□					∅10	∅10
H	∅40	∅95	∅95	∅62	∅60	∅45
N°	50.000	50.001	50.003	50.004	50.005	50.006

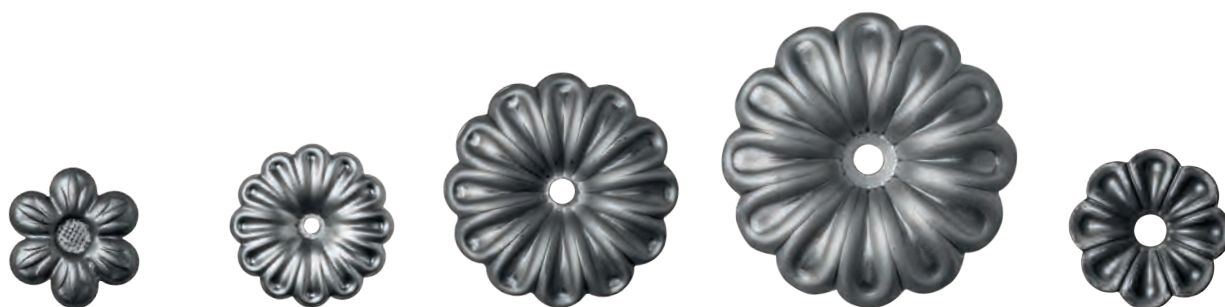

≠	2	1,2	2	2	2
□		∅5,5	∅10	∅12	∅12
H	∅57	∅66	∅95	∅120	∅60
N°	50.009	50.010	50.011	50.012	50.014



≠	2	2	2	1,5	0,8	0,8
□		∅10	∅10	∅8	∅8	∅7,5
H	∅100	∅140	∅85	∅45	∅70	∅110
N°	50.021	50.021.01	50.022	50.023	50.024	50.025

KWIATY I LIŚCIE

flowers and leaves / цветы и листья / Blumen und Blätter

105



#	0,8	0,8	0,8
□	∅5	∅10	∅20
H	∅46	∅70	∅115
N°	50.029	50.030	50.031

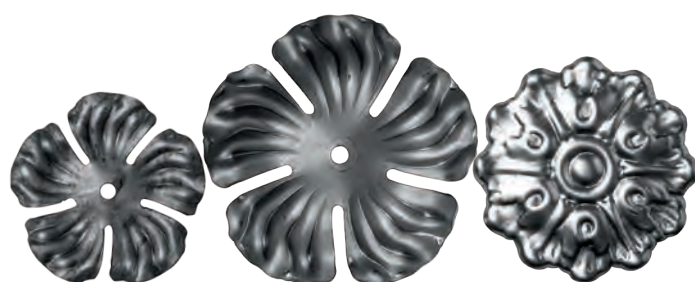
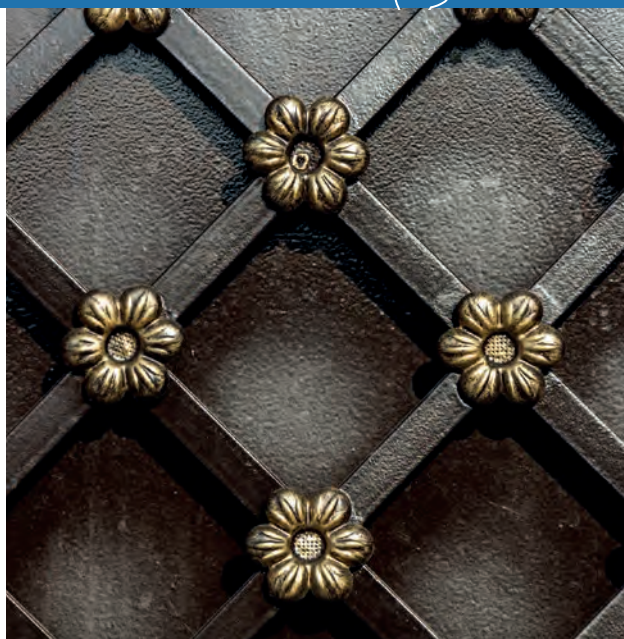

#	2	2	0,8
□	∅7	∅7	
H	∅87	∅120	∅100
N°	50.042	50.043	50.051



#	2	2	2
□			
H	∅85	∅115	∅95
N°	50.054	50.055	50.056





≠	1,5	1,5	1,5
□	95	75	50
H	170	190	140
N°	50.062	50.063	50.064



≠	1,2	1,2	1,2
H	ø60	ø50	ø35
N°	50.095	50.096	50.097



L	200	70	125	45
H	450	100	200	60
N°	50.100	50.101	50.102	50.103

KWIATY I LIŚCIE

flowers and leaves / цветы и листья / Blumen und Blätter



107



≠			2	2	
L	140	30	50	40	
H	200	75	125	80	
N°	50.104	50.105	50.106	50.107	



≠	2	2	1	1,5	
L	50	35	33	50	90
H	115	80	45	50	340
N°	50.111	50.112	50.108	50.110	50.109



≠	2,5	
L	40	140
H	80	320
N°	50.122	50.124

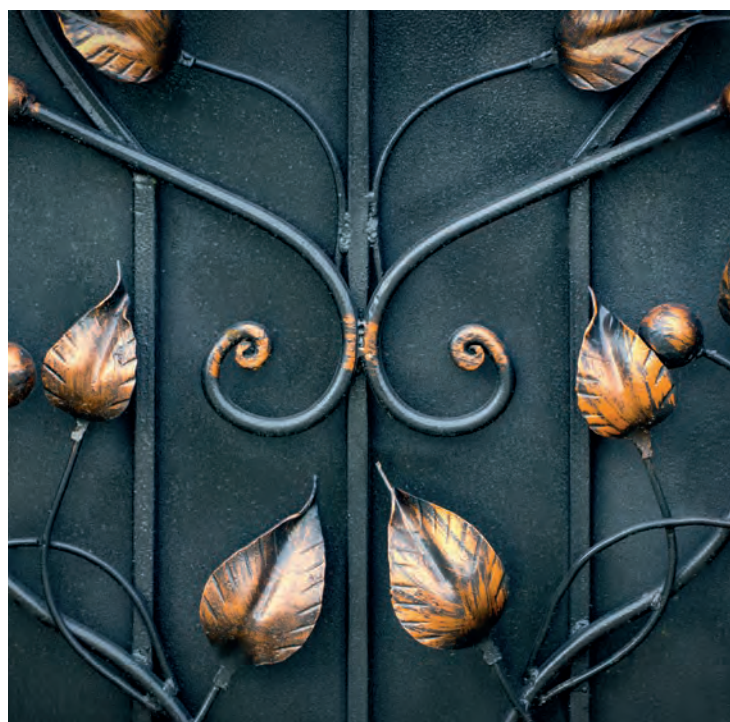

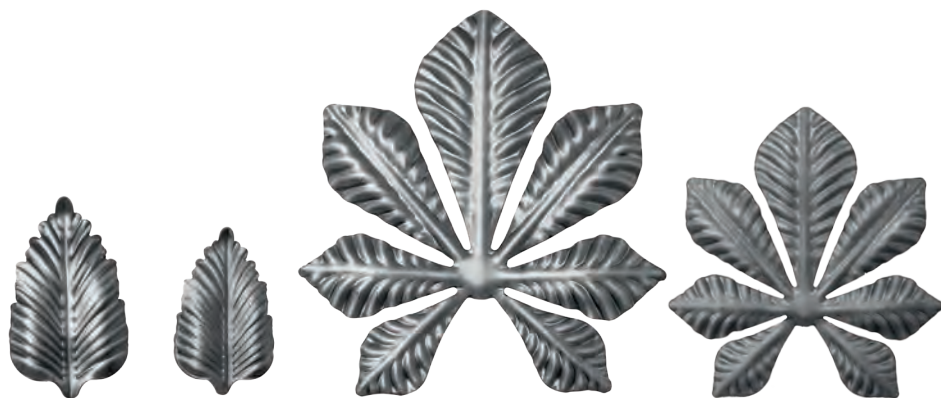

≠	2	2	2	2
L	70	50	220	150
H	115	85	210	160
N°	50.133	50.134	50.136	50.138



≠	2,5	2,5	2,5
L	40	37	30
H	130	115	90
N°	50.143	50.143.01	50.143.02



≠	25	20	2	2	2
L			90	75	55
H	95	56	170	140	100
N°	50.153	50.154	50.150	50.151	50.152

KWIATY I LIŚCIE

flowers and leaves / цветы и листья / Blumen und Blätter

109

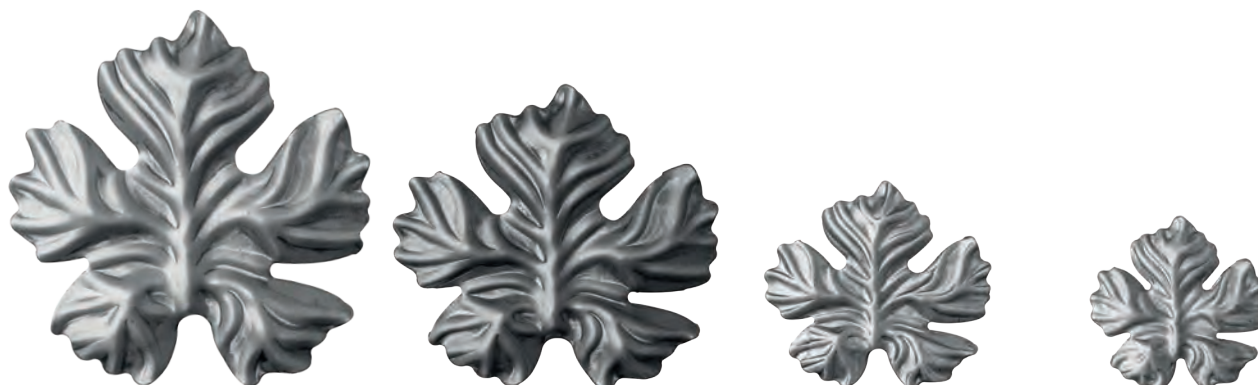

≠	2	2	2	2
L	150	115	95	70
H	150	125	85	70
N°	50.156	50.157	50.158	50.159



≠	1,5	1,5	1,5		
L	100	75	50	60	60
H	105	75	50	160	120
N°	50.160	50.161	50.162	50.165	50.166



≠	12	12	2	2
L	190	190	110	75
H	430	430	155	115
N°	50.175	50.176	50.182	50.183



≠						
L	170	105	45	75	110	110
H	410	275	250	210	200	200
N°	50.188	50.189	50.190	50.195	50.196	50.197



≠			
L	200	140	142
H	115	85	150
N°	50.200	50.201	50.210



KWIATY I LIŚCIE

flowers and leaves / цветы и листья / Blumen und Blätter



111



≠	2	2	2
L	140	105	70
H	120	90	60
N°	50.211	50.212	50.213



≠	2	2	2	2
L	200	155	125	95
H	190	165	135	100
N°	50.216	50.217	50.218	50.219





≠	2	2
L	54	55
H	130	130
N°	50.229	50.230



≠	2,5	2,5	2,5	2,5
L	140	70	150	70
H	200	190	260	240
N°	50.236	50.237	50.238	50.239



≠	2,5	2,5	2,5	2,5
L	120	60	60	85
H	370	350	350	280
N°	50.240	50.241	50.242	50.243

KWIATY I LIŚCIE

flowers and leaves / цветы и листья / Blumen und Blätter

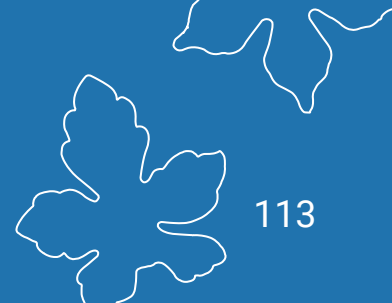

113



≠	2,5	2,5
L	50	50
H	250	250
N°	50.244	50.245



≠	2,5	2,5	2,5	2,5
L	200	200	100	100
H	210	210	270	270
N°	50.255	50.256	50.257	50.258





≠	2,5	2,5	2	2	2	2
L	50	50	92	92	60	60
H	90	90	112	112	80	80
N°	51.003	51.004	51.015	51.016	51.017	51.018



≠	2	2	2	2	2	2
L	69	69	40	40	30	30
H	185	185	110	110	90	90
N°	51.059	51.060	51.061	51.062	51.063	51.064



≠	2	2	2	2	2	2
L	60	60	70	70	75	75
H	80	80	65	65	110	110
N°	51.069	51.070	51.073	51.074	51.077	51.078

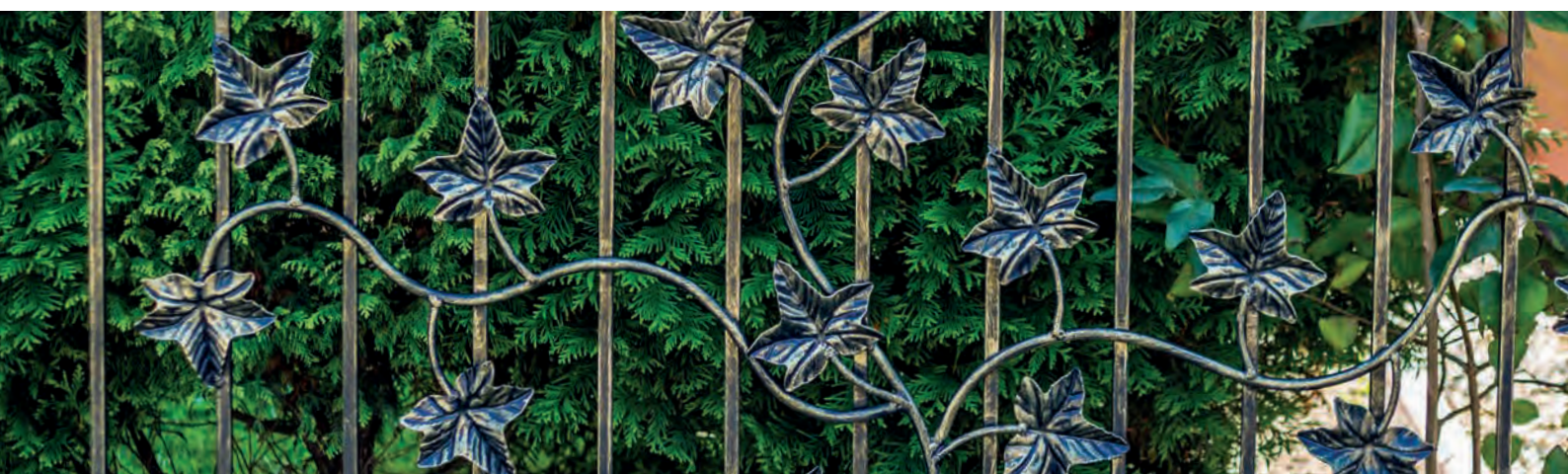

KWIATY I LIŚCIE

flowers and leaves / цветы и листья / Blumen und Blätter



115

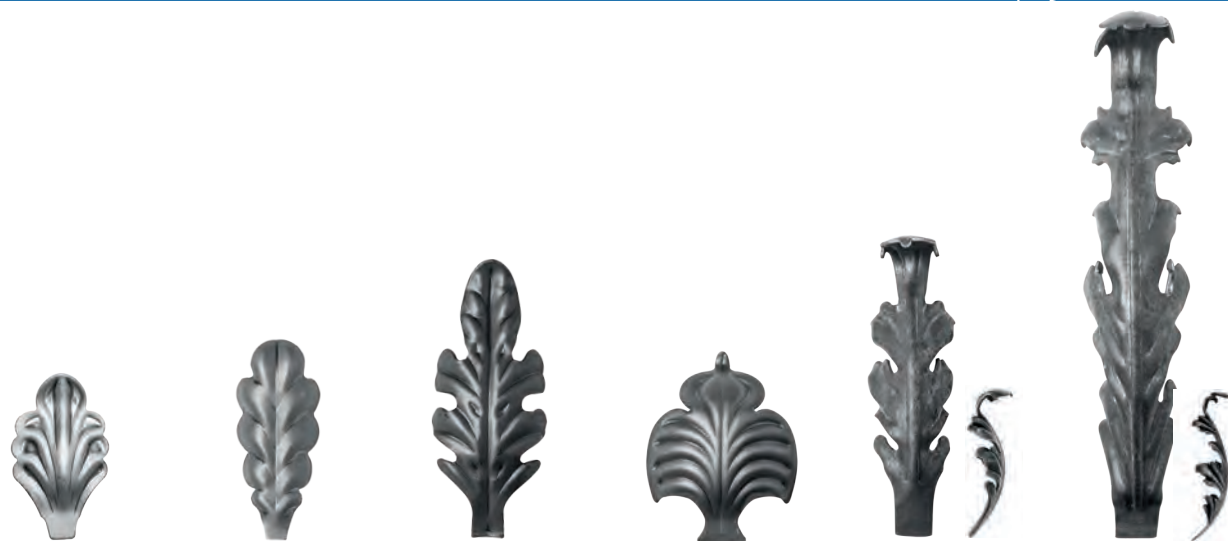

≠	2	2	2	2	2	2
L	48	45	47	72	45	60
H	88	108	150	100	160	280
N°	51.079	51.080	51.082	51.083	51.097	51.098



≠	3	2,5	2,5	2,5	3	3
L	50	38	60	75	60	55
H	105	125	150	150	300	290
N°	51.099	51.101	51.102	51.103	51.104	51.105





≠	4	4	4	2	1,5
L	110	92	100	100	135
H	350	295	330	260	70
N°	51.106	51.107	51.108	51.108.01	51.110



≠	1,8	1,8	4	4
L	150	150	175	175
H	100	100	215	215
N°	51.113	51.114	51.115	51.116



KWIATY I LIŚCIE

flowers and leaves / цветы и листья / Blumen und Blätter



117



#	2	2	2	2
L	95	95	175	175
H	200	200	295	295
N°	51.121	51.122	51.123	51.124



#	2	2	2	2
L	135	135	130	130
H	230	230	164	164
N°	51.125	51.126	51.127	51.128





≠	2	2	2	2
L	140	140	140	140
H	240	240	240	240
N°	51.129	51.130	51.133	51.134



≠	2	2	2	2	2
L	75	50	50	56	70
H	260	255	235	285	240
N°	51.140	51.143	51.144	51.145	51.147



KWIATY I LIŚCIE

flowers and leaves / цветы и листья / Blumen und Blätter



119



≠	2	2	2	2
L	95	95	130	72
H	110	110	143	85
N°	51.153	51.154	51.235	51.236



≠	2	2	2	1,2
L	210	210	145	180
H	340	340	243	260
N°	51.240	51.241	51.251	51.252





≠	2	2	0,8
L	180	165	110
H	260	165	110
N°	51.253	51.254	51.418



≠	1,2	2
L	300	50
H	225	225
N°	51.451	51.452



≠	0,8
L	570
H	120
N°	51.427



≠	0,8
L	1000
H	80
N°	51.449



STAR FLEX 

NIEZAWODNE TARCZE DO CIĘCIA I SZLIFOWANIA



ODLEWY STALIWNE I ŻELIWNE

cast steel items and cast iron items
литая сталь и чугунные элементы
Stahlguss und Gusseisenwaren

52.003 - 55.200

POSTAL®



≠	4	4	4	4
L	95	95	155	155
H	120	120	280	280
N°	52.003	52.004	52.005	52.006



≠	4	4	4	4
L	65	65	115	115
H	140	140	175	175
N°	52.009	52.010	52.011	52.012



≠	4	4	4	4
L	110	110	160	160
H	140	140	190	190
N°	52.013	52.014	52.015	52.016

ODLEWY STALIWNE

cast steel items / литая сталь / Stalguss

125



≠	4	4	4	4
L	140	140	150	150
H	155	155	250	250
N°	52.017	52.018	52.019	52.020



≠	4	4	4	4
L	120	120	85	85
H	210	210	180	180
N°	52.021	52.022	52.023	52.024



≠	4	4	4	4
L	125	125	140	75
H	165	165	215	170
N°	52.025	52.026	52.029	52.030



≠	4	4	4	4
L	105	48	60	75
H	235	120	190	135
N°	52.034	N 52.043.01	52.044	52.047



≠	4	4	4	4
L	120	120	∅150	∅90
H	210	211		45
N°	52.049	52.050	52.130	52.131



≠	3	4,5	5	3
H	∅90	∅90	∅115	∅50
N°	52.132	52.133	52.134	52.139

ODLEWY STALIWNE

cast steel items / литея сталь / Stalguss

127



≠	4	2	4
L	75	110	80
H	125	155	122
N°	52.201	52.202	52.203



L	100	140
H	145	200
N°	52.211	52.212



□	∅5	∅5
L	28	43
H	180	160
N°	52.216	52.217





≠	8	8	8
H	ø85	ø55	ø93
N°	52.300	52.301	52.305



≠	8	10
L	100	135
H	195	210
N°	52.406	52.420



≠	0,5	0,5	0,5
L		45	35
H	ø80	85	70
N°	53.000	53.008	53.009

ODLEWY ŻELIWNE

cast iron items / чугунные элементы / Gusseisenwaren

129

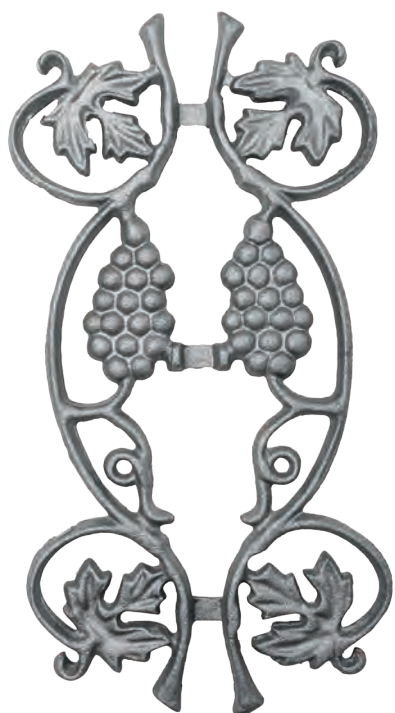

≠	14x14	14x14	14x14
L	190	175	200
H	380	400	455
N°	55.001	55.003	55.005



≠	14x14	14x14	14x14	14x14
L	138	130	225	180
H	165	280	315	260
N°	55.006	55.007	55.008	55.009

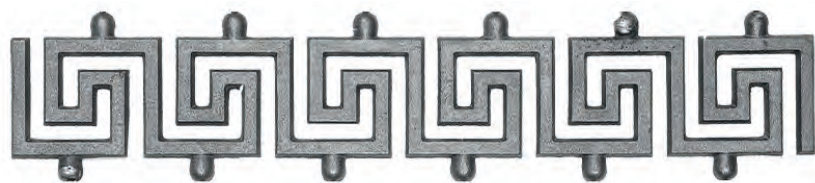

H	108
L	500
N°	55.030

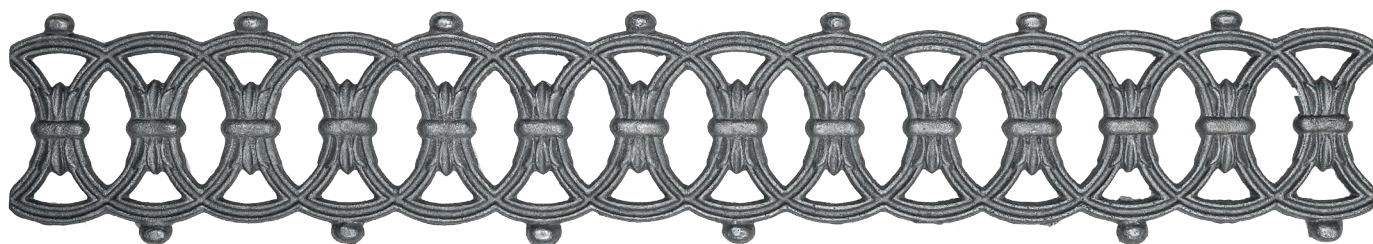

H	150
L	870
N°	55.031

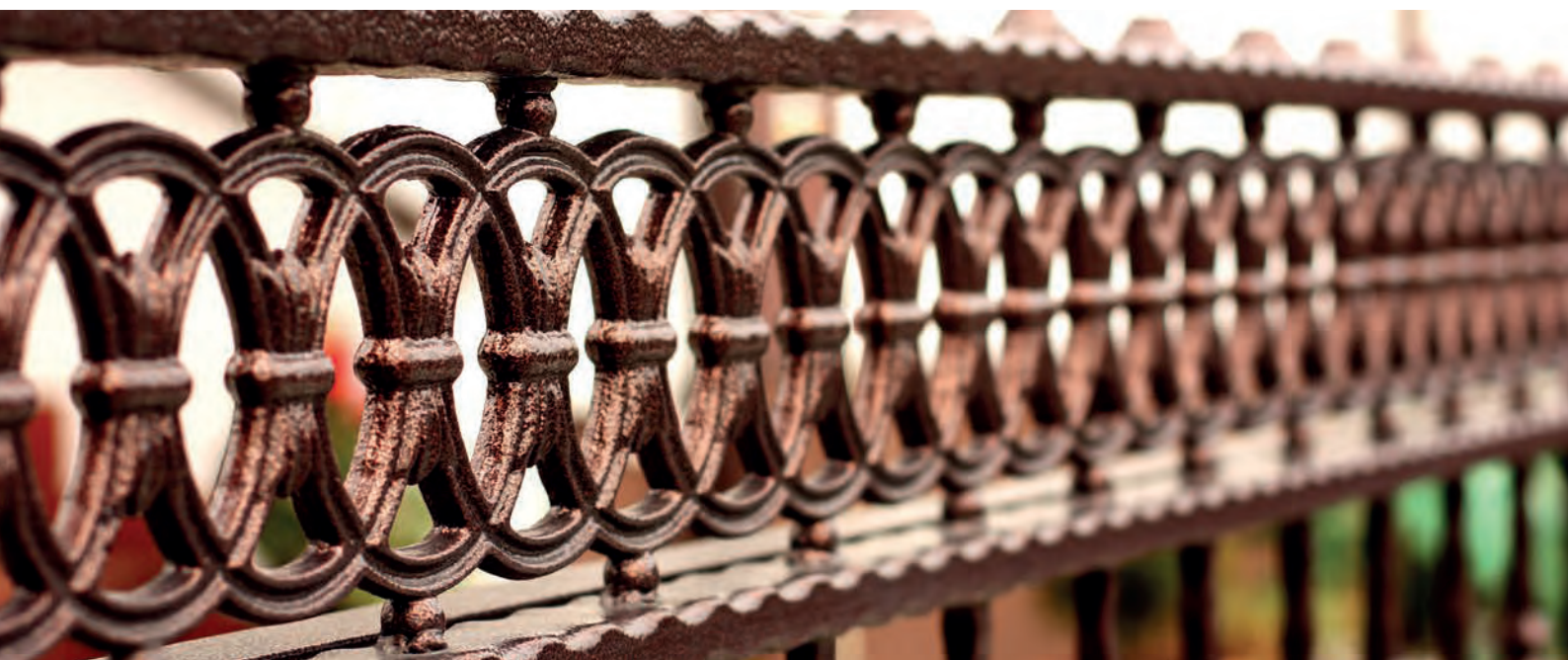

ODLEWY ŻELIWNE

cast iron items / чугунные элементы / Gusseisenwaren

131



L		165
H	∅120	250
N°	55.050	55.200



□	∅100
L	110
H	210
N°	55.100



□	40	50	60	80	100
L	40	50	60	80	100
H	87	110	135	160	180
N°	55.101	55.102	55.103	55.104	55.105

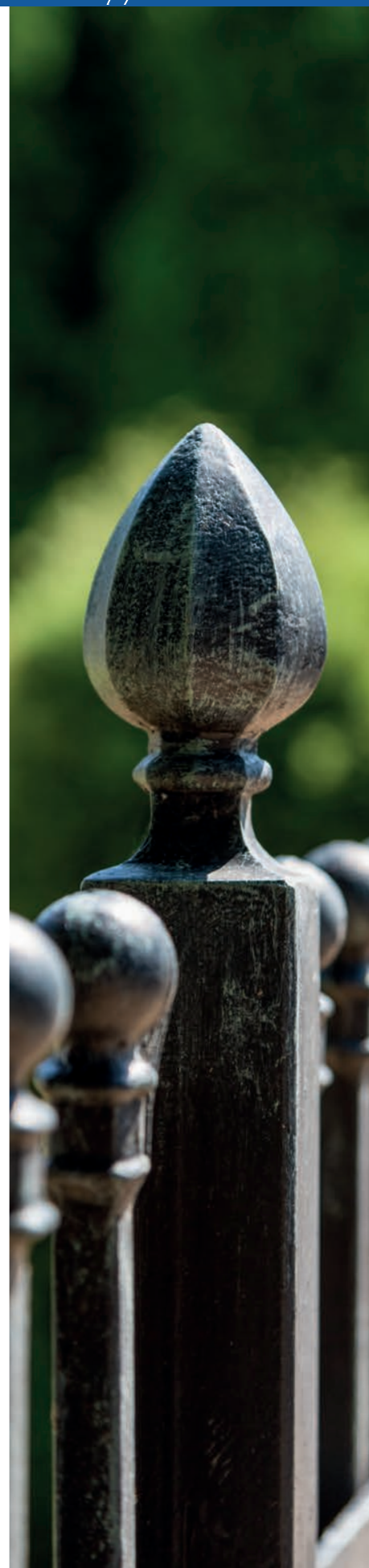



BLACHY

metal sheets
листовой металл
Stahlblech

56.010 - 56.090.12.01

POSTAL[®]

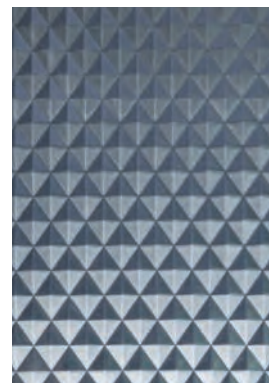
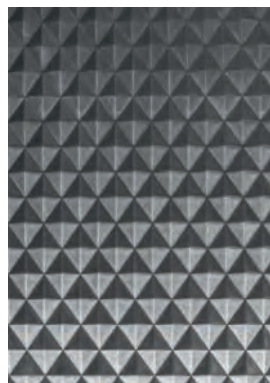
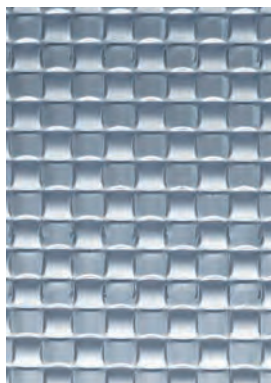

ocynk / galvanized

ocynk / galvanized

□	1,2	1,2	1,2	1,2
H	2000	2000	2000	2000
L	1000	1000	1000	1000
N°	56.010.12	56.010.12.01	56.020.12	56.020.12.01

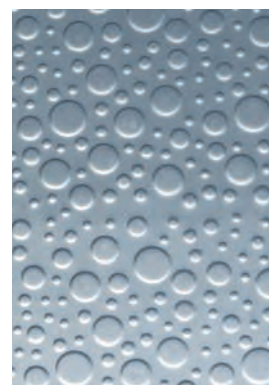
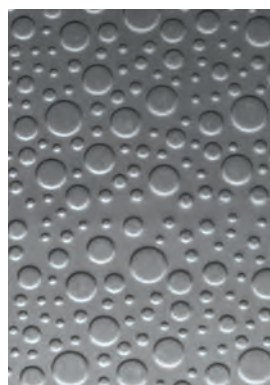

ocynk / galvanized

□	1,2	1,2	1,2
H	2000	2000	2000
L	1000	1000	1000
N°	56.030.12	56.040.12	56.040.12.01



BLACHY

metal sheets / листовый металл / Stahlblech

135

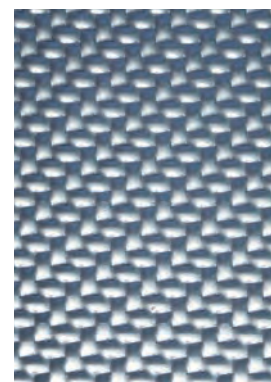
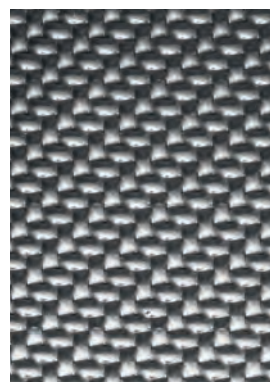
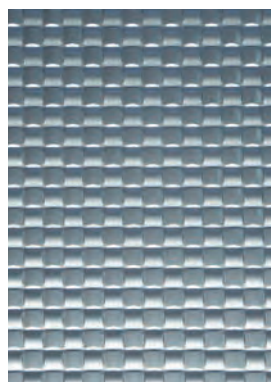
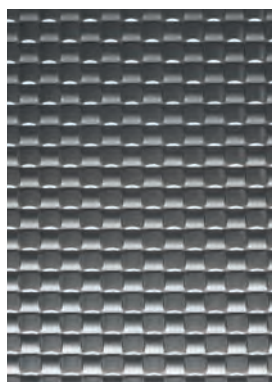

ocynk / galvanized

ocynk / galvanized

□	1,2	1,2	1,2	1,2
H	2000	2000	2000	2000
L	1000	1000	1000	1000
N°	56.050.12	56.050.12.01	56.060.12	56.060.12.01

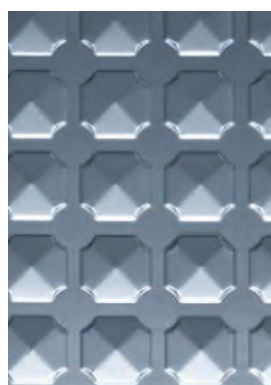

ocynk / galvanized

ocynk / galvanized

□	1,2	1,2	1,2	1,2
H	2000	2000	2000	2000
L	1000	1000	1000	1000
N°	56.070.12	56.070.12.01	56.080.12	56.080.12.01



ocynk / galvanized

□	1,2	1,2
H	2000	2000
L	1000	1000
N°	56.090.12	56.090.12.01



Czekamy na Ciebie! Zaloguj się na naszą platformę zakupową www.bonmario.com lub zadzwoń do swojego Opiekuna!



Wózki

Cantilever gate carriages / Несущие каретки / Laufrollenböcke



Uchwyty i najazdy

Guide wheels and end stops / Ловители и ролики / Auflaufelemente



Rolki prowadzące

Nylon rollers / Ведущие ролики / Führungsrollen



Szyny do bram

Rails for cantilever gates / Направляющие шины для ворот / Torprofile

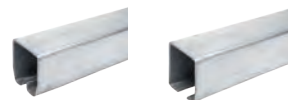

Listwy zębate do bram

Gear Racks / Зубчатые рейки для ворот / Zahnstangen



akcesoria do bram i ogrodzeń
hardware

PSG



Rolki jezdne

Sliding gate wheels / Ролики / Torrollen



System podwieszany

Hanging doors system / Подвесная система / Hängende Schiebetorsysteme



Zawiasy regulowane

Adjustable hinges / Регулируемые петли / Scharniere einstellbar



Stopery

Stoppers / Отбойники / Stopper

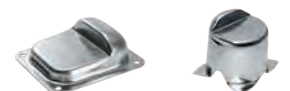

...i dużo więcej! / ...and much more!

ZAWIASY

ТОЧЗОНЕ I PASOWE

hingos

петли

Scharniere und Ladenbänder

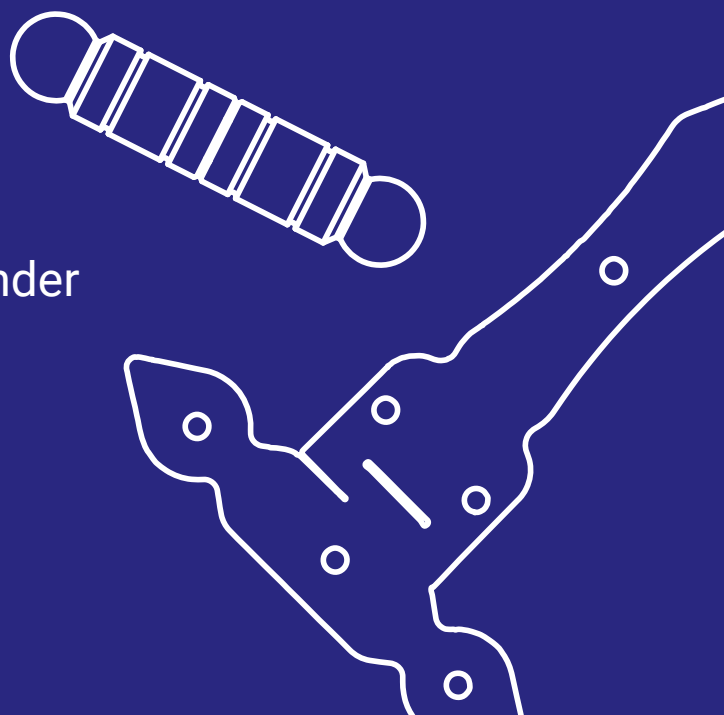

61.100 - 61.326

PSG

ZAWIASY TOCZONE I PASOWE

hinges / петли / Scharniere und Ladenbänder

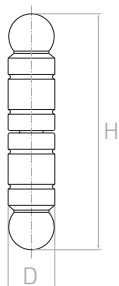

Zawias ozdobny

Welding hinge /
Петля приварная /
Scharnier



	D	H
61.100	ø20	100
61.101	ø29	130

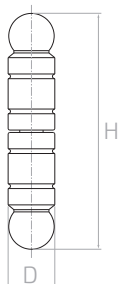

Zawias ozdobny

Welding hinge /
Петля приварная /
Scharnier



	D	H
61.102	ø20	100
61.103	ø24	122
61.104	ø30	146
61.105	ø30	230

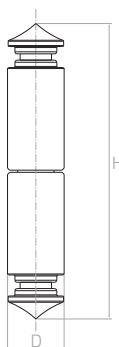

Zawias ozdobny z kulą

Welding hinge with ball /
Петля приварная с шаром /
Scharnier mit Kugel



	D	S
61.106	ø27	145
61.107	ø35	190

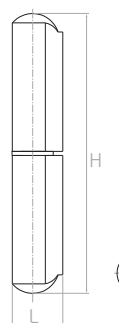

Zawias do spawania

Welding hinge /
Петля приварная /
Scharnier



	L	D	H
61.116.02	20	ø16	120
61.120.02	25	ø20	140
61.124.02	28	ø23	200

ZAWIASY TOCZONE I PASOWE

hinges / петли / Scharniere und Ladenbänder

141

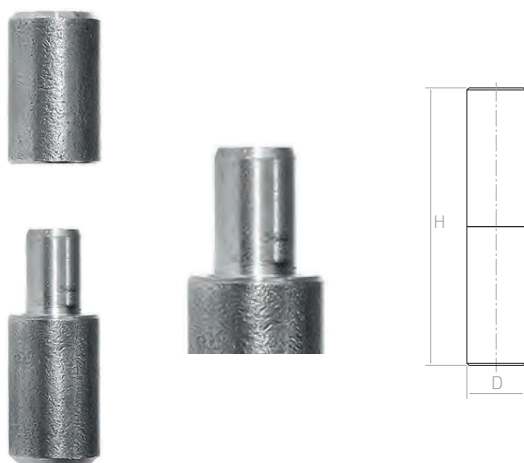

Zawias toczony

Welding hinge / Петля точеная приварная / Scharnier



	D	H
61.112	ø12	60
61.114	ø14	70
61.116	ø16	66
61.118	ø18	80
61.120	ø20	70
61.124	ø24	80
61.125	ø25	100
61.127	ø27	90
61.130	ø30	100
61.131	ø30	120
61.135	ø35	120
61.140	ø40	120

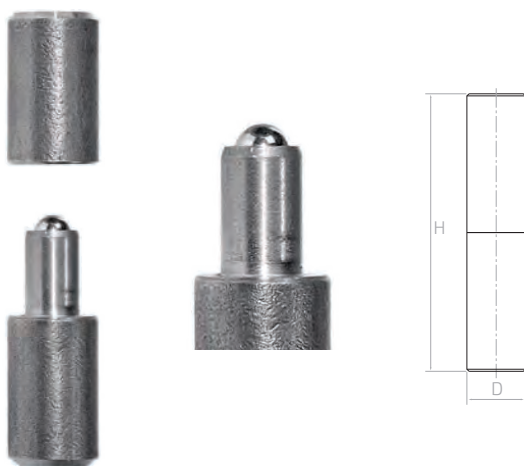

Zawias toczony z kulą

Welding hinge with ball / Петля точеная приварная с шаром / Scharnier mit Kugel



	D	H
61.114.01	ø14	70
61.116.01	ø16	66
61.118.01	ø18	80
61.120.01	ø20	70
61.124.01	ø24	80
61.125.01	ø25	100
61.127.01	ø27	90
61.130.01	ø30	100
61.131.01	ø30	120
61.135.01	ø35	120
61.140.01	ø40	120



Zawias skrzydełkowy

Welding hinge / Петля приварная / Scharnier



	L	D	A	S
61.120.03	120	20	46	4
61.124.03	140	24	76	5

ZAWIASY TOCZONE I PASOWE

hingies / петли / Scharniere und Ladenbänder

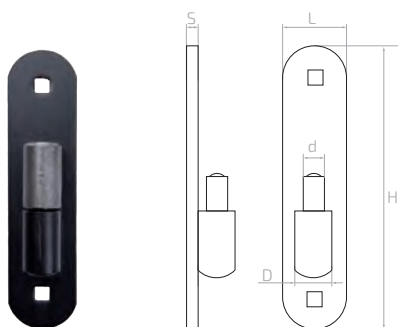

Zawias do przykręcenia
Hinge / Петля / Scharnier



	d	D	H	L	≠
61.201		ø24	150	40	4
61.202	ø16	ø27	200	50	5,5

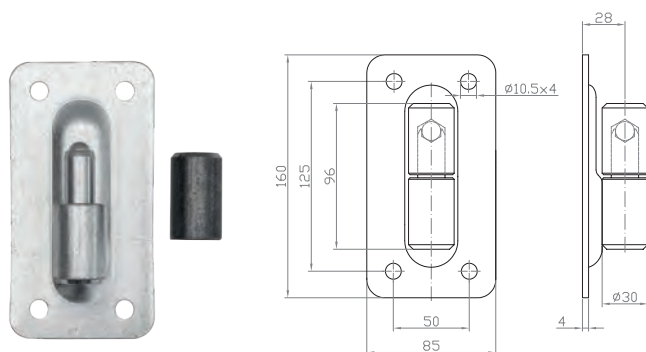

Zawias toczony, kulowy ø30
Hinge / Петля / Scharnier



	H	L
61.203	160	85

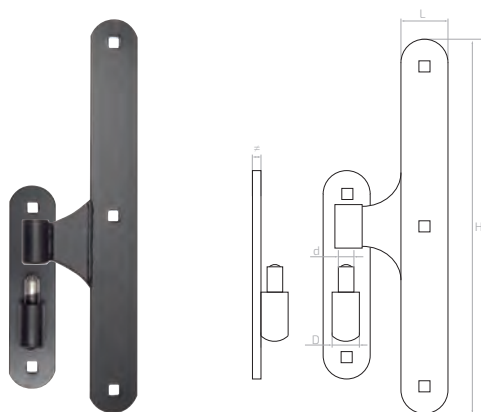

Zawias środkowy
Hinge / Петля / Scharnier



	d	D	H	L	≠
61.211	ø16	ø27	400	50	5,5

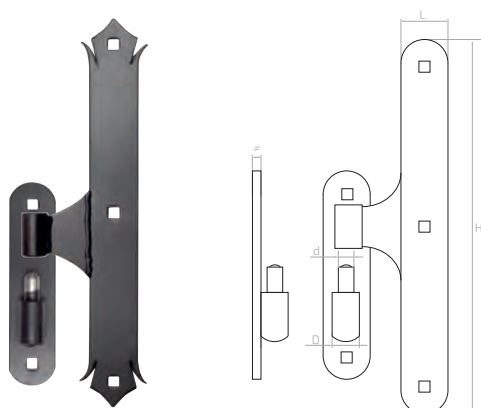

Zawias środkowy ozdobny
Hinge / Петля / Scharnier



	d	D	H	L	S
61.212	ø16	ø27	400	50	5,5

ZAWIASY TOCZONE I PASOWE

hinges / петли / Scharniere und Ladenbänder

143

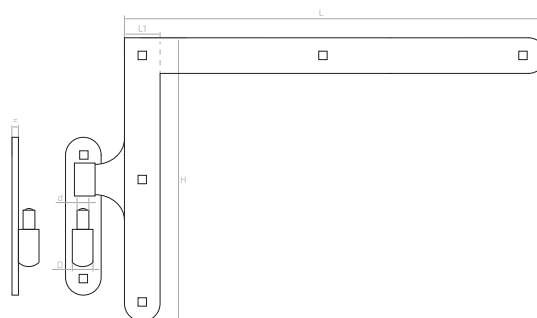

Zawiasy kątowe
Hinge / Петля / Scharnier



	d	D	H	L	L1	z
N 61.221.02 górny i dolny/ up and down	ø16	ø27	400	650	50	5

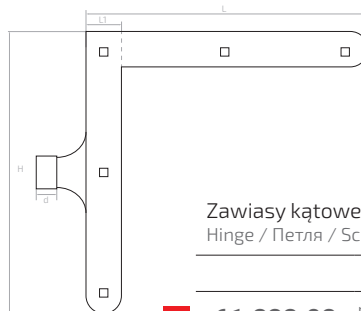

Zawiasy kątowe
Hinge / Петля / Scharnier



	d	H	L	L1	z
N 61.222.02 prawy i lewy/ right and left	ø14	250	285	35	4

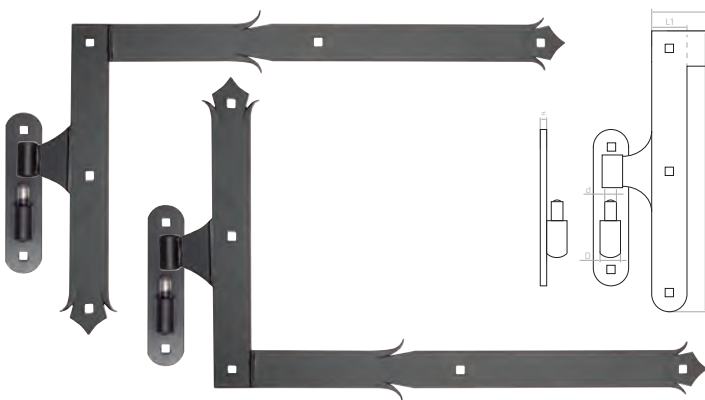

Zawiasy kątowe ozdobne
Hinge / Петля / Scharnier



	d	D	H	L	L1	z
N 61.223.02 górny i dolny/ up and down	ø16	ø27	400	650	50	5

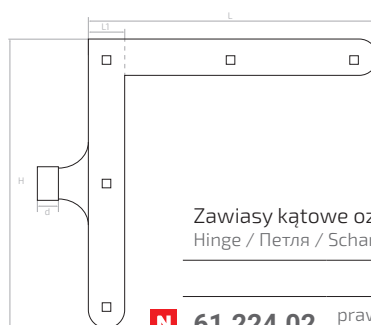
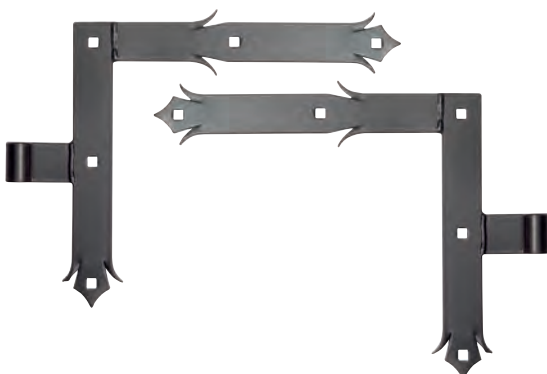

Zawiasy kątowe ozdobne
Hinge / Петля / Scharnier



	d	H	L	L1	z
N 61.224.02 prawy i lewy/ right and left	ø14	250	285	35	4

ZAWIASY TOCZONE I PASOWE

hinges / петли / Scharniere und Ladenbänder



Zawias pasowy
Hinge / Петля / Torband



	d	L	H	≠
61.251	ø14	400	35	4



Zawias pasowy
Hinge / Петля / Torband



	d	L	H	≠
61.252	ø14	600	35	4
61.253	ø18	800	40	5,5



Zawias pasowy
Hinge / Петля / Torband



	d	L	H	≠
61.254	ø18	1000	50	5,5



Zawias pasowy
Hinge / Петля / Torband



	d	L	H	≠
61.255	ø20	1150	60	6



Zawias pasowy ozdobny
Hinge / Петля / Torband



	d	L	H	≠
61.256	ø14	500	35	4
61.257	ø18	700	50	5,5

ZAWIASY TOCZONE I PASOWE

hinges / петли / Scharniere und Ladenbänder

145



Czop do przykręcenia

Pin /
Петлержатель прикручиваемый /
Torband Dorn



	d	H	L	≠
61.261	ø14	35	150	4
61.262	ø18	40	200	5,5
61.263	ø18	50	230	6
61.264	ø20	60	280	8



Czop do przykręcenia ozdobny

Pin /
Петлержатель прикручиваемый /
Torband Dorn



	d	H	L	≠
61.265	ø14	35	150	4



Czop do wmurowania

Built-in pin /
Петлержатель под застройку в стену /
Torband Dorn zum Einbetonieren



	d	H	L	≠
61.271	ø14	35	150	5,5
61.272	ø18	40	200	6
61.273	ø18	50	215	6
61.274	ø20	60	270	8



Wzmocnienie narożnika

Hinge / Петля / Torbeschlag



	H	L	≠
61.300	150	150	3
61.301	200	200	3

ZAWIASY TOCZONE I PASOWE

hinges / петли / Scharniere und Ladenbänder



Zawias ozdobny
Hinge / Петля / Scharnier



	L	H	≠
61.302	165	184	3
61.303	215	248	3



Zawias ozdobny pasowy
Hinge / Петля / Torband



	L	H	≠
61.304	218	125	3



Zawias ozdobny pasowy
Hinge / Петля / Torband



	L	H	≠	
61.305	lewy left / левая / Links	342	178	3
61.306	prawy right / правая / Recht	342	178	3

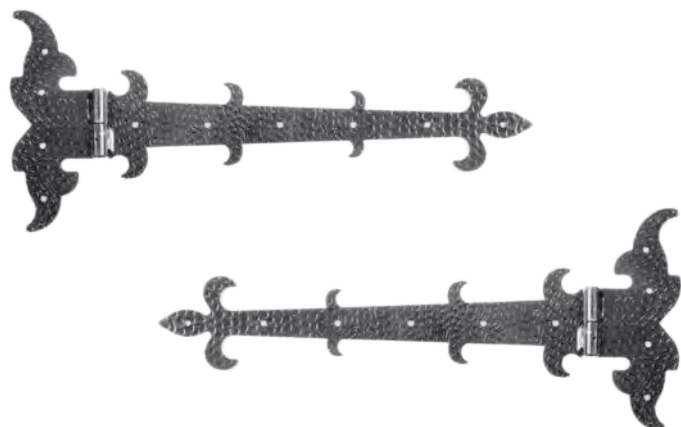

Zawias ozdobny pasowy
Hinge / Петля / Torband



	L	H	≠	
61.307	lewy left / левая / Links	525	225	3
61.308	prawy right / правая / Recht	525	225	3

ZAWIASY TOCZONE I PASOWE

hinges / петли / Scharniere und Ladenbänder

147



Zawias ozdobny pasowy
Hinge / Петля / Torband



	L	H	≠
61.314	217	148	3



Zawias ozdobny pasowy
Hinge / Петля / Torband



		L	H	≠
61.315	lewy left / левая / Links	357	207	3
61.316	prawy right / правая / Recht	357	207	3



Zawias ozdobny pasowy
Hinge / Петля / Torband



		L	H	≠
61.317	lewy left / левая / Links	500	270	3
61.318	prawy right / правая / Recht	500	270	3



ZAWIASY TOCZONE I PASOWE

hinges / петли / Scharniere und Ladenbänder



Zawias krzyżowy altanowy
Hinge / Петля / Torband



	L	H	≠
N 61.320	280	280	2,8



Zawias altanowy
Hinge / Петля / Torband



	L	H	≠
N 61.321	255	90	2,8

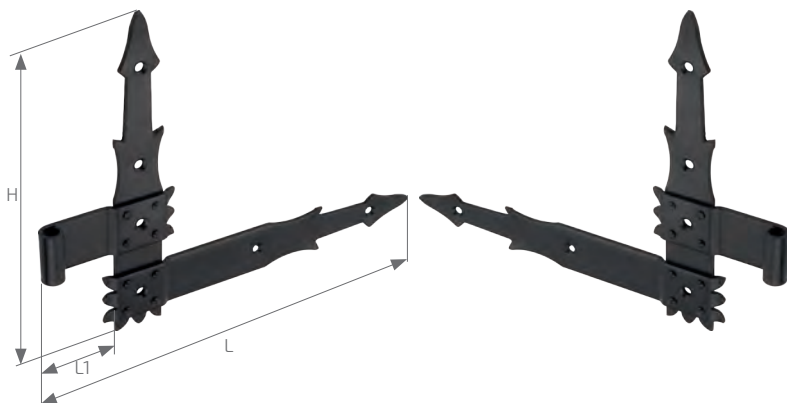

Zawias kątowy okiennicowy
Hinge / Петля / Torband



		d	L	L1	H	≠
N 61.322	lewý left / левая / Links	ø9	295	45	220	2,8
N 61.323	prawy right / правая / Recht	ø9	295	45	220	2,8

ZAWIASY TOCZONE I PASOWE

hinges / петли / Scharniere und Ladenbänder

149



Zaczep budowlany okiennicowy
Pin / Петледержатель прикручиваемый /
Torband Dorn



	d	H	L	≠
N 61.324	ø9	95	35	2,5



Zawias krzyżowy ozdobny
Hinge / Петля / Torband



	d	H	L	≠
N 61.325	ø6	260	135	4



Zaczep budowlany okiennicowy
Pin / Петледержатель прикручиваемый /
Torband Dorn



	d	H	L	≠
N 61.326	ø6	120	40	4,5



Sprawdź pełną gamę zawiasów w katalogu
Check the full range of hinges in the catalogue

PSG

DASZKI

post caps, крышки, Deckel



więcej znajdziesz w katalogu PSG

	A	H	≠
62.101	180	170	3
62.102	150	165	3
62.103	130	140	3
62.104	110	125	3



PINOX

ELEMENTY ZE STALI NIERDZEWNEJ

Zapytaj swojego Opiekuna o katalog produktów PINOX!



KLAMKI I UCHWYTY

door handles
ручки
Türdrücker und Griffe



63.001 - 63.038

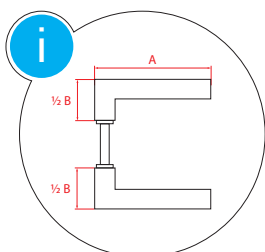

POSTAL®

KLAMKI I UCHWYTY

door handles / ручки / Türdrücker und Griffe

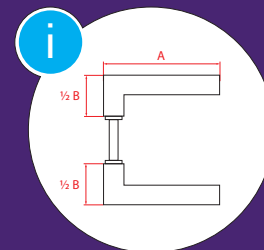

	A	B	
63.001	145	85	ocynk / galvanized



	A	B	
63.003	160	95	ocynk / galvanized



	A	B	
63.005	165	85	ocynk / galvanized



	A	B	
63.006	140	95	-
63.006.01	140	85	ocynk / galvanized



	A	B	
63.007	135	90	ocynk / galvanized



	A	B	
63.012	130	80	-

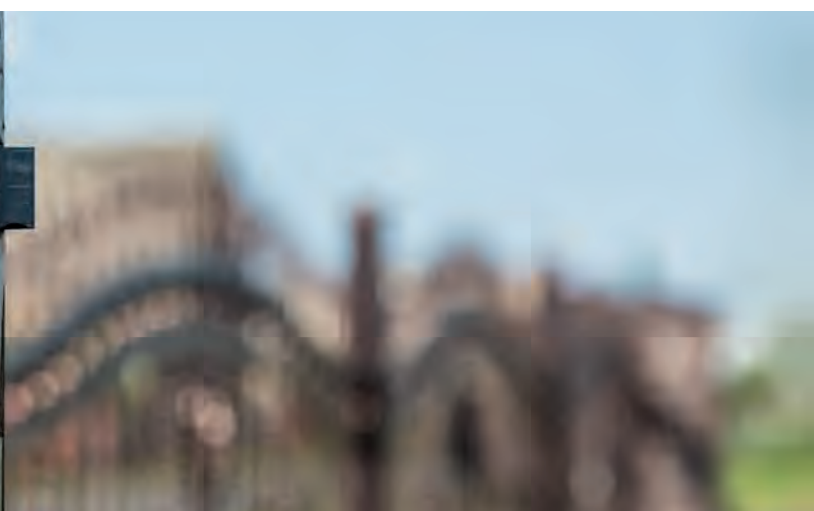

KLAMKI I UCHWYTY

door handles / ручки / Türdrücker und Griffe



155



	A	B	
63.013	142	90	-



	A	B	
N 63.013.01	142	90	-



	A	B	
63.021	120	80	ocynk / galvanized



	A	B	
63.022	130	65	ocynk / galvanized



	A	B	
63.029	155	80	ocynk / galvanized



	A	B	
63.030	155	90	ocynk / galvanized



KLAMKI I UCHWYTY

door handles / ручки / Türdrücker und Griffe

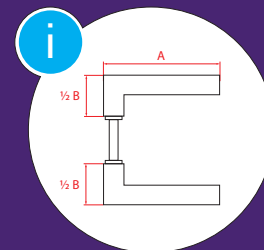

	A	B
63.031	150	80



	A	B	
63.031.01	150	70	ocynk / galvanized



	A	B
63.032	165	80



	A	B	
63.034	145	80	ocynk / galvanized



	A	B	
63.038	155	85	ocynk / galvanized



	A	B	
63.035	120	80	malowana / painted



	A	B	
63.036	120	80	malowana / painted



KLAMKI I UCHWYTY

door handles / ручки / Türdrücker und Griffe



157



	H	L	
63.002*	60	ø 65	malowana / painted



	H	L	
63.008	85	ø 70	-

* do wyprzedania zapasu



	H	L	
63.009	70	ø 70	-



	H	L	
63.010	65	ø 65	-



	H	L	
63.011	55	ø 70	-



	H	L	
63.015	70	105	-



KLAMKI I UCHWYTY

door handles / ручки / Türdrücker und Griffe



	H	L	
63.016	110	105	-



	H	L	
63.017	60	ø 65	-



	H	L	
63.018	70	ø 65	-



	H	L	
63.027	80	ø 68	-



	H	L	
63.028	100	ø 68	-



	H	L	
63.020	55	65	-



KLAMKI I UCHWYTY

door handles / ручки / Türdrücker und Griffe



159



	H	L	
63.024	290	80	-



	H	L	
63.025	390	75	-



Sprawdź pełną gamę klamek w katalogu
Check the full range of door handles in the catalogue

PSG





SZYLDY

shields
накладки
Schlosskastenblenden



63.040 - 63.194.90.00

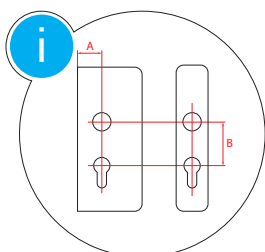

PSG

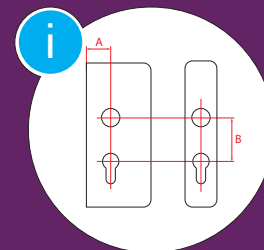

1

2

N		D	≠
1	63.040	∅ 65	2
2	63.041	∅ 65	2



1

2

N		D	≠
1	63.044	∅ 52	3
2	63.045	∅ 52	3



H

L

≠

63.142

230

40

5



1



2

N		H	L	≠
1	63.046	105	37	3
2	63.047	105	37	3



H

L

≠

B

63.138.72.00

263

60

3

72

63.138.90.00

263

60

3

90



H

L

≠

B

63.139.72.00

260

52

3

72

63.139.90.00

260

52

3

90



H

L

≠

B

63.140.72.00

263

50

3

72

63.140.90.00

263

50

3

90



H

L

≠

B

63.141.90.00

260

56

3

90

SZYLDY

shields / накладки / Schlosskastenblenden

163



1 2

N		H	L	≠	A	B
1	63.165.72.50	295	136	2	50	72
2	63.166.72.50	295	136	2	50	72

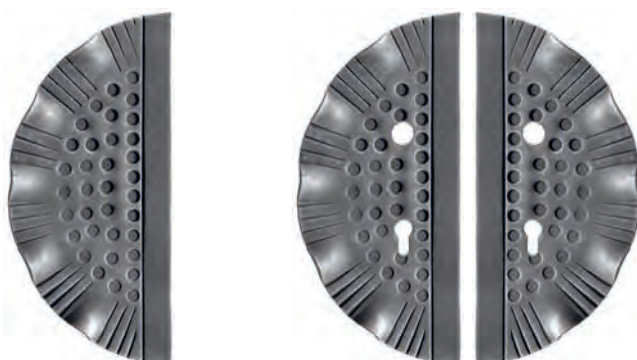

1 2 3

N		H	L	≠	A	B
1	63.101.00.00	272	125	2,5	-	-
2	63.102.72.50	272	125	2,5	50	72
3	63.103.72.50	272	125	2,5	50	72
2	63.102.90.50	272	125	2,5	50	90
3	63.103.90.50	272	125	2,5	50	90

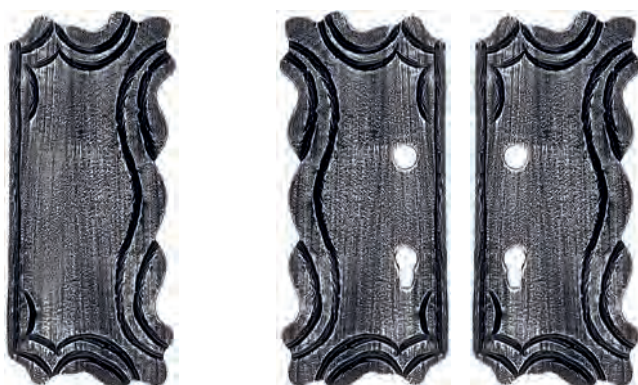

1 2 3

N		H	L	≠	A	B
1	63.108.00.00	322	141	3	-	-
2	63.109.72.50	322	141	3	50	72
3	63.110.72.50	322	141	3	50	72
2	63.109.90.50	322	141	3	50	90
3	63.110.90.50	322	141	3	50	90



1 2 3

N		H	L	≠	A	B
1	63.111.00.00	320	98	3	-	-
2	63.112.90.50	320	98	3	50	90
3	63.113.90.50	320	98	3	50	90

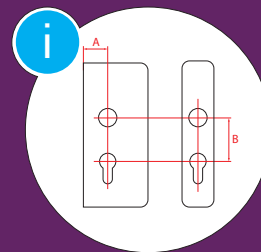

1



2

3

N		H	L	≠	A	B
1	63.114.00.00	288	123	3	-	-
2	63.115.90.35	288	123	3	35	90
3	63.116.90.35	288	123	3	35	90



1



2

3

N		H	L	≠	A	B
1	63.146.00.00	320	98	3	-	-
2	63.149.72.50	317	135	2	50	72
3	63.150.72.50	317	135	2	50	72
2	63.147.90.50	317	135	2	50	90
3	63.148.90.50	317	135	2	50	90



1



2

3

N		H	L	≠	A	B
1	63.185.00.00	310	116	2	-	-
2	63.186.90.50	310	116	2	50	90
3	63.187.90.50	310	116	2	50	90



1

2



3

4

N		H	L	≠	A	B
1	63.117.00.00	272	160	2,5	-	-
2	63.118.00.00	272	160	2,5	-	-
3	63.119.72.50	272	160	2,5	50	72
4	63.120.72.50	272	160	2,5	50	72
3	63.119.90.50	272	160	2,5	50	90
4	63.120.90.50	272	160	2,5	50	90

SZYLDY

shields / накладки / Schlosskastenblenden

165



1 2

3 4

N		H	L	≠	A	B
1	63.125.00.00	285	160	2	-	-
2	63.126.00.00	285	160	2	-	-
3	63.127.72.50	285	160	2	50	72
4	63.128.72.50	285	160	2	50	72
3	63.127.90.50	285	160	2	50	90
4	63.128.90.50	285	160	2	50	90

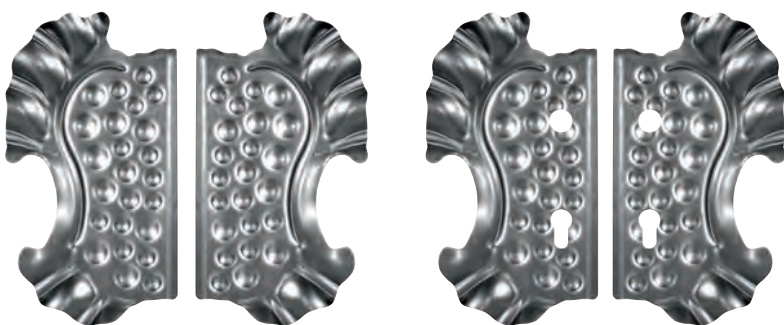

1

2

3

4

N		H	L	≠	A	B
1	63.134.00.00	286	158	2	-	-
2	63.135.00.00	286	158	2	-	-
3	63.136.72.50	286	158	2	50	72
4	63.137.72.50	286	158	2	50	72
3	63.136.90.50	286	158	2	50	90
4	63.137.90.50	286	158	2	50	90



1

2

3

4

N		H	L	≠	A	B
1	63.151.00.00	330	172	2	-	-
2	63.152.00.00	330	172	2	-	-
3	63.153.72.50	330	172	2	50	72
4	63.154.72.50	330	172	2	50	72
3	63.153.90.50	330	172	2	50	90
4	63.154.90.50	330	172	2	50	90



1

2

3

4

5

N		H	L	≠	A	B
1	63.129.00.00	272	110	2,5	-	-
2	63.130.00.50	272	110	2,5	50	-
3	63.131.00.50	272	110	2,5	50	-
4	63.130.72.50	272	110	2,5	50	72
5	63.131.72.50	272	110	2,5	50	72
4	63.130.90.50	272	110	2,5	50	90
5	63.131.90.50	272	110	2,5	50	90

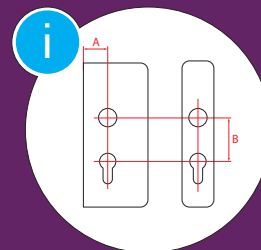

Szyld z gałką ruchomą

Door knob with shield / Ручка с накладкой / Türgriff mit Rosette

	H	L	A	B	
63.188.90.00	270	36	100	90	malowany / painted



Szyld z klamką i gałką ruchomą

Door handle and knob with shield / Ручка с накладкой / Türdrücker, Griff mit Rosette

	H	L	A	B	
63.189.90.00	270	36	100	90	malowany / painted



Szyld z klamką

Door handle with shield / Ручка с накладкой / Türdrücker mit Rosette

	H	L	A	B	
63.190.90.00	270	36	100	90	malowany / painted

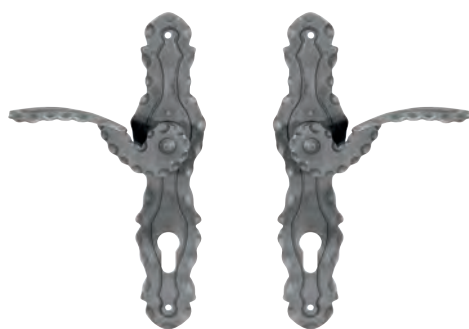

1

2

Szyld z klamką

Door handle with shield / Ручка с накладкой / Türdrücker mit Rosette

N		H	L	≠	B
1	63.191.72.00	263	60	3	72
2	63.192.72.00	263	60	3	72
1	63.191.90.00	263	60	3	90
2	63.192.90.00	263	60	3	90

SZYLDY

shields / накладки / Schlosskastenblenden

167

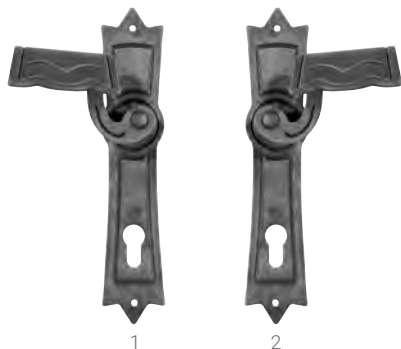

1

2

Szyld z klamką

Door handle with shield / Ручка с накладкой / Türdrücker mit Rosette

N		H	L	≠	B
1	63.193.90.00	260	52	3	90
2	63.194.90.00	260	52	3	90



Szyldy z klamkami

Door handle with shield / Ручка с накладкой / Türdrücker mit Rosette

	H	L	B	
63.180.72.00	240	30	72	malowana / painted
63.180.90.00	240	30	90	malowana / painted



Szyldy z klamką i gałką stałą

Door handle and knob with shield / Ручка с накладкой / Türdrücker, Griff mit Rosette

	H	L	B	
63.181.72.00	240	30	72	malowana / painted
63.181.90.00	240	30	90	malowana / painted



Szyldy z gałkami stałymi

Door knob with shield / Ручка с накладкой / Türgriff mit Rosette

	H	L	B	
63.182.72.00	240	30	72	malowana / painted
63.182.90.00	240	30	90	malowana / painted



Łącznik

Welding lug / Соединитель / Anschweislasche

	H	L	≠
64.003	50	25	5
64.004	50	30	5



Łącznik do zawiasu

Welding lug / Соединитель / Anschweislasche

	M	H	L	≠
64.014	16	100	40	8
64.015	18	90	60	8
64.016	20	90	60	8



Łącznik do zawiasu

Welding lug / Соединитель / Anschweislasche

	M	H	L	≠
N 64.017	16	75	40	8



Łącznik do zawiasu

Welding lug / Соединитель / Anschweislasche

	M	H	L	≠
N 64.018	20	120	120	8



Element ozdobny kuty

Decorative element / Соединитель / Lasche

	H	L	≠
64.005	102	25	5

AKCESORIA MOCUJĄCE

fixing elements / крепления / Befestigungszubehör

169

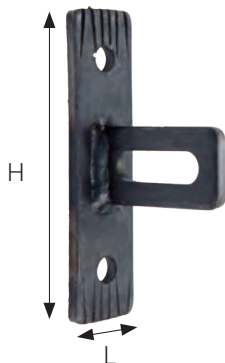

Element ozdobny kuty

Decorative element / Соединитель / Lasche

	H	L	≠
64.006	102	25	5



Mocowanie pręśta rozporowe

Finishing element / Пристенное крепление / Lasche mit Dübel

	H	L	∅	
64.007	130	25	∅ 12	ocynk / galvanized
64.008	130	30	∅ 12	ocynk / galvanized



Uchwyt montażowy szeroki (2 śruby)

Mounting bracket / Монтажный кронштейн / Montagehalterung

	H	L	≠
N 64.800	60	25	4



Uchwyt montażowy szeroki ozdobny

Mounting bracket / Монтажный кронштейн / Montagehalterung

	H	L	≠
N 64.801	95	28	4



Łącznik pręśta ogrodzeniowego – do przykręcenia

Mounting bracket / Монтажный кронштейн / Montagehalterung

	H	L	≠
N 64.019	80	25	3

AKCESORIA MOCUJĄCE

fixing elements / крепления / Befestigungszubehör



□	12x12	12x12	∅14
L	95	95	95
H	180	180	180
N°	64.011	64.012	64.013



□	∅6	∅6	∅6	∅10	∅10
L	∅19	∅25	∅18	∅21	19
H	36	25	36	32	30
N°	64.020	64.021	64.022	64.023	64.024

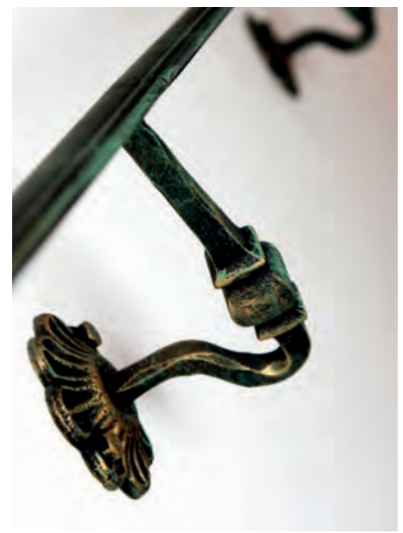

AKCESORIA MOCUJĄCE

fixing elements / крепления / Befestigungszubehör



171



Nakrętka kołpakowa

Nut / Винт колпачковый оцинкованный /
Verschlusskappe verzinkt

	d	H	
64.035	M8	15	ocynk / galvanized
64.036	M10	18	ocynk / galvanized
64.037	M12	22	ocynk / galvanized



Stalowy łącznik śrubowy

Screw connector / Стальной соединитель с резьбой /
Gewindestange verzinkt

	d	L	
64.040	M8	1000	ocynk / galvanized
64.041	M10	1000	ocynk / galvanized
64.042	M12	1000	ocynk / galvanized
64.043	M14	1000	ocynk / galvanized
64.044	M16	1000	ocynk / galvanized





SKRZYNKI NA LISTY

mail boxes
ПОЧТОВЫЕ ЯЩИКИ
Briefkästen

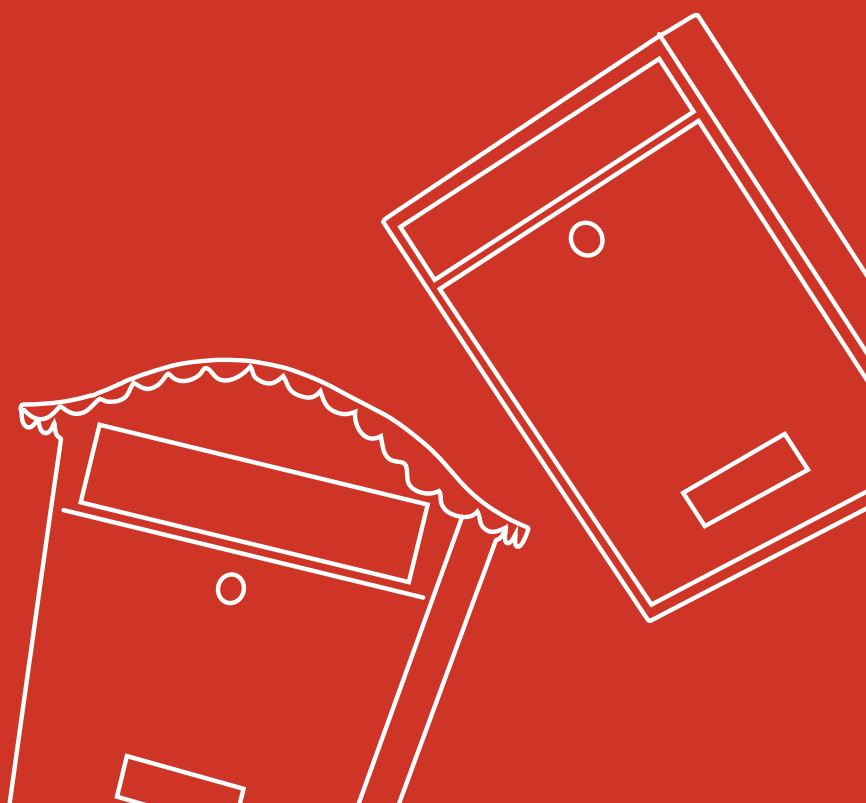

65.200 - 65.259

SKRZYNKI NA LISTY

mail boxes / почтовые ящики / Briefkästen



	H	L	D			kolor / colour
65.200	405	255	90	A4	aluminium / stal	czarny / black
65.202	405	255	90	A4	aluminium / stal	miedz / copper
65.203	405	255	90	A4	aluminium / stal	grafit / graphite



	H	L	D			kolor / colour
65.210	435	385	180	A4	aluminium	czarny / black
65.211	435	385	180	A4	aluminium	miedz / copper



SKRZYNKI NA LISTY

mail boxes / почтовые ящики / Briefkästen

175

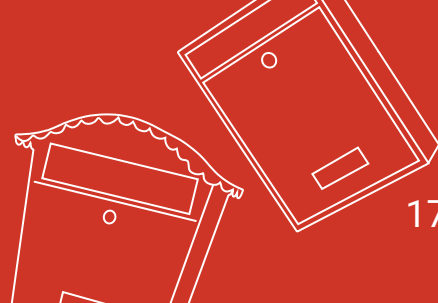

Skrzynka natynkowa
Surface-mounted letter box / Почтовый ящик /
Aufputzmontage Briefkasten



	H	L	D		kolor
N 65.212	375	370	110	stal / steel	czarny / black



Skrzynka natynkowa
Surface-mounted letter box / Почтовый ящик /
Aufputzmontage Briefkasten



	H	L	D		kolor
N 65.213	403	410	130	stal / steel	srebrny / silver



	H	L	D		kolor / colour
65.250	372	355	133	A4 stal	czarny / black



SKRZYNKI NA LISTY

mail boxes / почтовые ящики / Briefkästen

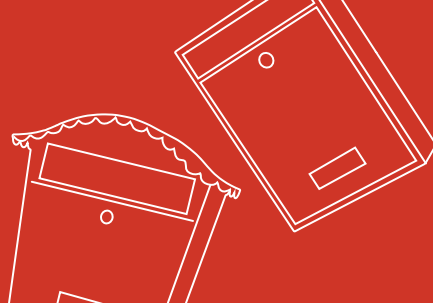

	H	L	D			kolor / colour
65.257.01	320	215	85	A4	stal	czarny / black



	H	L	D			kolor / colour
65.259	400	270	118	A4	stal	czarny / black



Sprawdź pełną gamę skrzynek na listy w katalogu
Check the full range of mail boxes in the catalogue

PSG



LAMPY

lamps / лампы / Lampen



177



	H	L	D	
66.003.01	670	310	420	ocynk / galvanized



	H	L	
66.004.01	400	300	ocynk / galvanized



	H	L	
66.006.01	380	290	ocynk / galvanized



NOGI DO ŁAWEK

bench legs / ножки для скамеек / Bankfüße

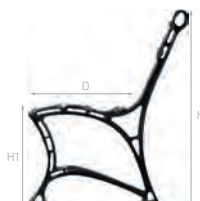

Noga aluminiowa do ławki
Bench leg / Алюминиевая нога скамьи /
Bankfuß

	H	H1	D
66.050	750	400	390

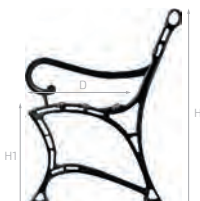

Noga aluminiowa do ławki z podłokietnikiem
Bench leg with armrest / Алюминиевая нога скамьи с подлокотником /
Bankfuß mit Armlehne

	H	H1	D
66.051	750	400	390

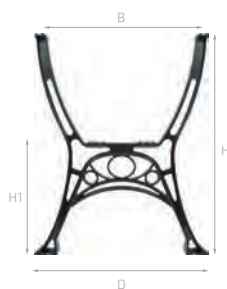

Noga aluminiowa do stołu
Table leg / Алюминиевая нога стола /
Tischbein Aluminium

	H	H1	D	B
66.060	690	365	580	465

NOGI DO ŁAWEK

bench legs / ножки для скамеек / Bankfüße



179

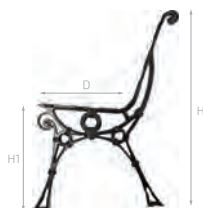

Noga aluminiowa do ławki
Bench leg / Алюминиевая нога скамьи /
Bankfuß

	H	H1	D
66.052	730	405	290

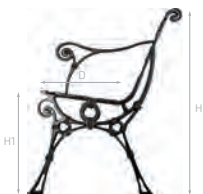

Noga aluminiowa do ławki z podłokietnikiem
Bench leg with armrest / Алюминиевая нога скамьи с подлокотником /
Bankfuß mit Armlehne

	H	H1	D
66.053	730	405	290



Noga stalowa do ławki
Bench leg / Нога скамьи / Bankgestehl aus Stahl

	H	H1	D
66.070	840	440	460



Noga stalowa do stołu
Table leg / Стальная нога скамьи / Tischgestehl aus Stahl

	H	D	B
66.075	745	740	800



POSTAL



POSTAL



FARBA
STYRENOWO-AKRYLOWA

DO METALU GRAFIT

POSTAL



FARBA
ENOWO-AKRYLOWA

METALU
ANTYCZNA
GRAFIT

POSTAL
STEEL GR

FARBA
PODKŁADOVA
METAL CZER

POSTAL
STEEL GROUP

PATYNA
POLIWINYLOWA

POSTAL
STEEL GROUP

PATYNA
POLIWINYLOWA
ZŁOTO

POSTAL
STEEL GROUP

PATYNA
POLIWINYLOWA
ZŁOTO

POSTAL
STEEL GROUP

PATYNA
POLIWINYLOWA
MIEDŹ

TAL



FARBA
STYRENOWO-AKRYLOWA

ANTYCZNA
CZARNA

FARBY I PATYNY

paints and patinas
краски и патины
Farben und Patina



70.001 - 70.123

PSG



Farba podkładowa na metal czerwona
Steel undercoat paint / Грунтовка по металлу / Stahlunterlack

	opakowanie packaging / упаковка / Verpackung	
70.901	1 l	czerwona red
70.901.01	3 l	
70.901.02	10 l	



Farba podkładowa na ocynk czerwona
Galvanized undercoat paint /
Грунтовка по металлу для оцинкованных поверхностей /
Grundierung für verzinkten Stahl

	opakowanie packaging / упаковка / Verpackung	
70.911	1 l	czerwona red
70.911.01	3 l	
70.911.02	10 l	



Farba poliwinylowa
Polyvinyl paint / Поливиниловая краска / Polyvinyl-Farbe

	opakowanie packaging / упаковка / Verpackung	
70.001	1 l	grafit antyczny graphite antique
70.001.01	3 l	
70.001.02	10 l	



Farba poliwinylowa
Polyvinyl paint / Поливиниловая краска / Polyvinyl-Farbe

	opakowanie packaging / упаковка / Verpackung	
70.002	1 l	czarny antyczny black antique
70.002.01	3 l	
70.002.02	10 l	



Farba poliwinylowa
Polyvinyl paint / Поливиниловая краска / Polyvinyl-Farbe

	opakowanie packaging / упаковка / Verpackung	
70.003	1 l	brąz antyczny antique bronze
70.003.01	3 l	

FARBY I PATYNY

paints and patinas / краски и патины / Farben und Patina

183



Patyna poliwinylowa
Polyvinyl patina / Поливиниловая патина / Polyvinyl Patina

opakowanie
packaging /
упаковка /
Verpackung

70.101

0,23 l

patyna złoto
patina gold



Patyna poliwinylowa
Polyvinyl patina / Поливиниловая патина / Polyvinyl Patina

opakowanie
packaging /
упаковка /
Verpackung

70.102

0,23 l

patyna srebro
patina silver



Patyna poliwinylowa
Polyvinyl patina / Поливиниловая патина / Polyvinyl Patina

opakowanie
packaging /
упаковка /
Verpackung

70.103

0,23 l

patyna miedź
patina copper



Patyna poliwinylowa
Polyvinyl patina / Поливиниловая патина / Polyvinyl Patina

opakowanie
packaging /
упаковка /
Verpackung

70.104

0,23 l

patyna zielona
patina green



Patyna poliwinylowa
Polyvinyl patina / Поливиниловая патина / Polyvinyl Patina

opakowanie
packaging /
упаковка /
Verpackung

70.105

0,23 l

patyna jasnozielona
patina bright green





Farba styrenowo - akrylowa
Styrene-acrylic paint / Стирол - акриловая краска /
Styrol-Acrylfarbe

	opakowanie packaging / упаковка / Verpackung	
70.021	1 l	grafit antyczny graphite antique
70.021.01	3 l	
70.021.02	10 l	



Farba styrenowo - akrylowa
Styrene-acrylic paint / Стирол - акриловая краска /
Styrol-Acrylfarbe

	opakowanie packaging / упаковка / Verpackung	
70.022	1 l	czarny antyczny black antique
70.022.01	3 l	
70.022.02	10 l	

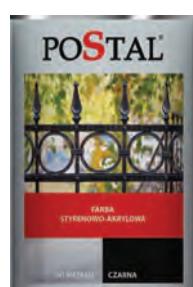

Farba styrenowo - akrylowa
Styrene-acrylic paint / Стирол - акриловая краска /
Styrol-Acrylfarbe

	opakowanie packaging / упаковка / Verpackung	
70.222	1 l	czarny black
70.222.01	3 l	
70.222.02	10 l	



Farba styrenowo - akrylowa
Styrene-acrylic paint / Стирол - акриловая краска /
Styrol-Acrylfarbe

	opakowanie packaging / упаковка / Verpackung	
70.321	1 l	grafit - matowa graphite - mat
70.321.01	3 l	
70.321.02	10 l	



Farba styrenowo - akrylowa
Styrene-acrylic paint / Стирол - акриловая краска /
Styrol-Acrylfarbe

	opakowanie packaging / упаковка / Verpackung	
70.322	1 l	czarna - matowa black - mat
70.322.01	3 l	
70.322.02	10 l	

FARBY I PATYNY

paints and patinas / краски и патины / Farben und Patina

185

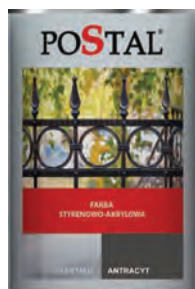

Farba styrenowo - akrylowa (strukturalna)
Styrene-acrylic paint / Стирол - акриловая краска /
Styrol-Acrylfarbe

opakowanie
packaging /
упаковка /
Verpackung

70.323
70.323.01

1 l
3 l

antracyt - półmat
anthracite - half-matt



Patyna styrenowo-akrylowa
styrene-acrylic patina / стирол - акриловая патина /
Styrol-Acryl-Patina

opakowanie
packaging /
упаковка /
Verpackung

70.121

0,23 l

patyna złoto
patina gold



Patyna styrenowo-akrylowa
styrene-acrylic patina / стирол - акриловая патина /
Styrol-Acryl-Patina

opakowanie
packaging /
упаковка /
Verpackung

70.122

0,23 l

patyna srebro
patina silver



Patyna styrenowo-akrylowa
styrene-acrylic patina / стирол - акриловая патина /
Styrol-Acryl-Patina

opakowanie
packaging /
упаковка /
Verpackung

70.123

0,23 l

patyna miedź
patina copper



KOTWY I AKCESORIA

anchors and accessories / химические анкера / Anker und Zubehör



Kotwy chemiczne
Chemical anchors / Химические анкера / Chemische Anker

		aprobata techniczna technical approval / техническое одобрение / technische Zulassung	opakowanie packaging / упаковка / Verpackung
71.300	letnia summer / летняя / Sommer	ITB - KOT	300 ml
71.410	letnia summer / летняя / Sommer	ITB - KOT	410 ml
71.410.01	zimowa winter / зимняя / Winter	ITB - KOT	410 ml
71.410.02	do stali nierdzewnej for stainless steel / к нержавеющей стали / für Edelstahl	ETA	410 ml



Mieszacz do kotwy chemicznej
Mixer for chemical anchor /
Насадка-миксер сменная для химического анкера / Mischer für chemische anker

	opakowanie packaging / упаковка / Verpackung
71.001	4 szt.



Tuleja siatkowa
Perforated sleeves / Втулка сеточная / Perforierte Buchse

	wymiary dimensions / Параметры / Abmessungen
74.012	∅ 12 x 50
74.015	∅ 15 x 85
74.015.01	∅ 15 x 130
74.020	∅ 20 x 85

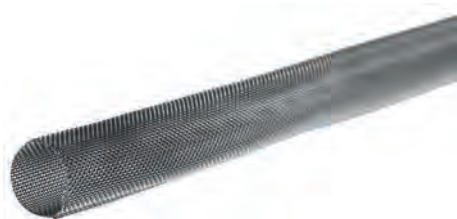

Tuleja siatkowa stalowa
Metal-mesh sleeves / Втулка сеточная / Perforierte Buchse

	wymiary dimensions / Параметры / Abmessungen
74.112	∅ 12 x 1000
74.115	∅ 16 x 1000



Wycior do czyszczenia otworów
Hole cleaning rod / Щетки для очистки отверстий / Lochwischer

	wymiary dimensions / Параметры / Abmessungen
75.010	∅ 10
75.013	∅ 13
75.018	∅ 18

KOTWY I AKCESORIA

anchors and accessories / хемические анкера / Anker und Zubehör

187



Pompka do wydmuchiwania zwiercin
Blowing machine pump / Насос для продувки отверстий / Bohrlochpumpe

75.025



Wyciskacz profesjonalny
Professional squeezer / Пистолет для выпрессовывания картриджей / Auspresspistole

75.030

300 ml



Wyciskacz profesjonalny
Professional squeezer / Пистолет для выпрессовывания картриджей / Auspresspistole

75.041

380 ml / 410 ml



Wyciskacz profesjonalny
Professional squeezer / Пистолет для выпрессовывания картриджей / Auspresspistole

75.041.01

380 ml / 410 ml



Platinum

STAR WIRE

STAR WIRE
STAR WIRE

STAR WIRE

CE	EN 12556	EN 12556	EN 12556
EN 12556	EN 12556	EN 12556	EN 12556
EN 12556	EN 12556	EN 12556	EN 12556



DRUT SPAWALNICZY • SCHWEIBDRAHT • SVAŘOVACÍ DRÁT • СВАРОЧНАЯ ПРОВОДКА

DRUT I AKCESORIA SPAWALNICZE

welding wire and accessories
сварочная проволока и принадлежности
Schweißdraht und Schweißzubehör

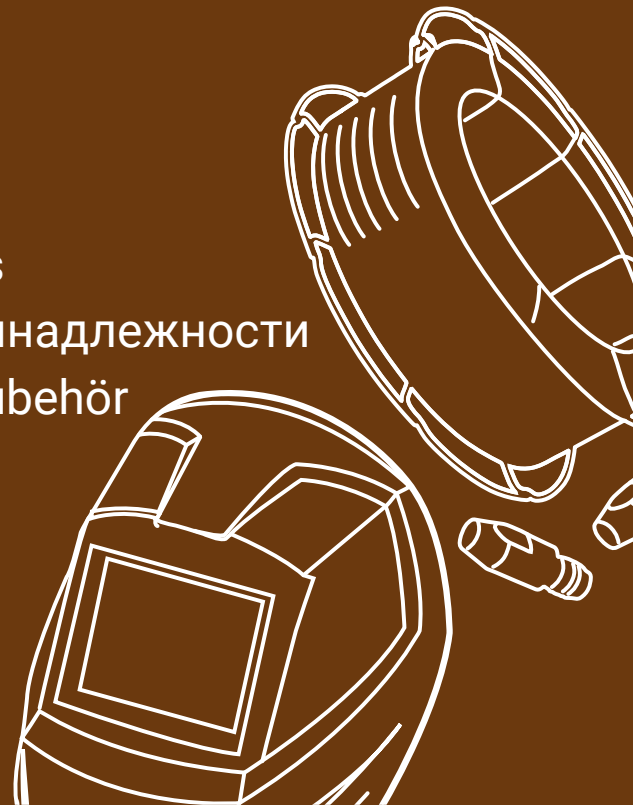

SP.001.08 - SWM.UCHWYT.01

Platinum

STAR
WIRE 

POSTAL[®]

DRUT I AKCESORIA SPAWALNICZE

welding wire and accessories / сварочная проволока и принадлежности /
Schweißdraht und Schweißzubehör

190

Platinum



Drut spawalniczy MIG MAG

MIG MAG welding wire / Сварочная проволока MIG MAG / Schweißdraht MIG MAG

	rodzaj kind вид Sorte	grubość thickness толщина Stärke	opakowanie packaging упаковка Verpackung	szpula spool шпуля Drahtspule	ilość na palecie quantity per pallet количество на палете Stückzahl pro Palette
SP.001.08	G3Si1/SG2	0,8	15 kg	metal	72
SP.002.10	G3Si1/SG2	1,0	15 kg	metal	72
SP.003.12	G3Si1/SG2	1,2	15 kg	metal	72

Platinum



Drut spawalniczy MIG MAG

MIG MAG welding wire / Сварочная проволока MIG MAG / Schweißdraht MIG MAG

	rodzaj kind вид Sorte	grubość thickness толщина Stärke	opakowanie packaging упаковка Verpackung	szpula spool шпуля Drahtspule	ilość na palecie quantity per pallet количество на палете Stückzahl pro Palette
SP.010.12	G4Si1/SG3	1,2	15 kg	metal	72



Drut jest zgodny z normą G3Si1, DIN EN ISO 14341-A, SFA/AWS 5.18:ER70S-6 posiada atesty TUV, DB42.142.01, ABS, LR.

The wire is compliant G3Si1, DIN EN ISO 14341-A, SFA/AWS 5.18:ER70S-6 is certified by TUV, DB42.142.01, ABS, LR.

Проволока соответствует нормам G3Si1, DIN EN ISO 14341-A, SFA/AWS 5.18:ER70S-6 аттестована TUV, DB42.142.01, ABS, LR.

Der Schweißdraht entspricht den Normen G3Si1, DIN EN ISO 14341-A, SFA/AWS 5.18:ER70S-6 ist zertifiziert TUV, DB42.142.01, ABS, LR.

DRUT I AKCESORIA SPAWALNICZE

welding wire and accessories / сварочная проволока и принадлежности /
Schweißdraht und Schweißzubehör

191



Drut spawalniczy MIG MAG

MIG MAG welding wire / Сварочная проволока MIG MAG / Schweißdraht MIG MAG

	rodzaj kind вид Sorte	grubość thickness толщина Stärke	opakowanie packaging упаковка Verpackung	szpula spool шпуля Drahtspule	ilość na palecie quantity per pallet количество на палете Stückzahl pro Palette
SP.001.08X	G3Si1/SG2	0,8	15 kg	metal	72
SP.002.10X	G3Si1/SG2	1,0	15 kg	metal	72
SP.003.12X	G3Si1/SG2	1,2	15 kg	metal	72



Drut spawalniczy MIG MAG

MIG MAG welding wire / Сварочная проволока MIG MAG / Schweißdraht MIG MAG

	rodzaj kind вид Sorte	grubość thickness толщина Stärke	opakowanie packaging упаковка Verpackung	szpula spool шпуля Drahtspule	ilość na palecie quantity per pallet количество на палете Stückzahl pro Palette
SP.004.08X	G3Si1/SG2	0,8	5 kg	plastik	200
SP.005.10X	G3Si1/SG2	1,0	5 kg	plastik	200

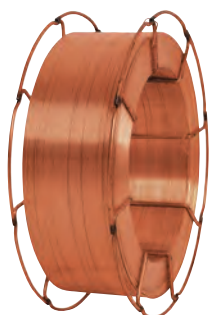

Drut spawalniczy MIG MAG

MIG MAG welding wire / Сварочная проволока MIG MAG / Schweißdraht MIG MAG

	rodzaj kind вид Sorte	grubość thickness толщина Stärke	opakowanie packaging упаковка Verpackung	szpula spool шпуля Drahtspule	ilość na palecie quantity per pallet количество на палете Stückzahl pro Palette
SP.011.10X	G4Si1/SG3	1,0	15 kg	metal	72



Drut proszkowy

Flux-cored welding wire / Порошковая проволока / Fülldraht

	rodzaj kind вид Sorte	grubość thickness толщина Stärke	opakowanie packaging упаковка Verpackung	szpula spool шпуля Drahtspule	ilość na palecie quantity per pallet количество на палете Stückzahl pro Palette
SPP.003.12X	E71T-1C H8	1,2	15 kg	plastik	72

DRUT I AKCESORIA SPAWALNICZE

welding wire and accessories / сварочная проволока и принадлежности /
Schweißdraht und Schweißzubehör



Sprężyna dyszy

Nozzle spring / Пружина сопла / Haltefeder

SPA.002.0058

15 AK

SPA.003.0013

25AK



Łącznik dyszy gazowej / łącznik prądowy

Tip holder with spring / Current connector /

Держатель газового сопла / Вставка для наконечника /
Gasdüsenträger / Stromdüsenträger /

SPA.002.0078 L

M6/M8 x 1

15 AK

lewy



Łącznik dyszy gazowej / łącznik prądowy

Tip holder with spring / Current connector /

Держатель газового сопла / Вставка для наконечника /
Gasdüsenträger / Stromdüsenträger /

SPA.142.0001

M6/M8

25 AK

lewy



Łącznik prądowy

Current connector / Вставка для наконечника / Stromdüsenträger

SPA.142.0003

M6

24 KD



Łącznik prądowy

Current connector / Вставка для наконечника / Stromdüsenträger

SPA.142.0020

M8

36 KD



Łącznik prądowy

Current connector / Вставка для наконечника / Stromdüsenträger

SPA.142.0022

M8

401D/501D

DRUT I AKCESORIA SPAWALNICZE

welding wire and accessories / сварочная проволока и принадлежности /
Schweißdraht und Schweißzubehör

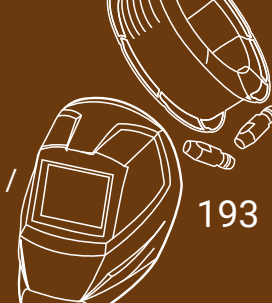

193

32,5



Rozdzielacz gazu

Gas diffuser / Диффузор газовый / Gasverteiler

SPA.012.0183	24 KD	standardowy
SPA.014.0023	36 KD	ceramiczny

28



Rozdzielacz gazu

Gas diffuser / Диффузор газовый / Gasverteiler

SPA.030.0145	401 D/501D	standardowy
---------------------	------------	-------------



Dysze gazowe

Gas nozzle / Газовое сопло / Gasdüsen

SPA.145.0075	15 AK	ø 12	stożkowa
---------------------	-------	------	----------



Dysze gazowe

Gas nozzle / Газовое сопло / Gasdüsen

SPA.145.0076	25 AK	ø 15	stożkowa
---------------------	-------	------	----------



Dysze gazowe

Gas nozzle / Газовое сопло / Gasdüsen

SPA.145.0080	24 KD	ø 12,5	stożkowa
SPA.145.0078	36 KD	ø 16	stożkowa



Dysze gazowe

Gas nozzle / Газовое сопло / Gasdüsen

SPA.145.0085	401 D / 501 D	ø 16	stożkowa
---------------------	---------------	------	----------

DRUT I AKCESORIA SPAWALNICZE

welding wire and accessories / сварочная проволока и принадлежности /
Schweißdraht und Schweißzubehör

194



Dysze prądowe

Contact tip / Токопроводящие наконечники / Stromdüsen

SPA.140.0008	15 AK	∅ 0,6	M6x25	E-Cu
SPA.140.0059	15 AK	∅ 0,8	M6x25	E-Cu
SPA.140.0253	15 AK	∅ 1,0	M6x25	E-Cu
SPA.140.0387	15 AK	∅ 1,2	M6x25	E-Cu



Dysze prądowe

Contact tip / Токопроводящие наконечники / Stromdüsen

SPA.140.0051	25 AK	∅ 0,8	M6x28	E-Cu
SPA.140.0054	25 AK	∅ 0,8	M6x28	CuCrZr
SPA.140.0242	25 AK	∅ 1,0	M6x28	E-Cu
SPA.140.0245	25 AK	∅ 1,0	M6x28	CuCrZr
SPA.140.0379	25 AK	∅ 1,2	M6x28	E-Cu
SPA.140.0382	25 AK	∅ 1,2	M6x28	CuCrZr



Dysze prądowe

Contact tip / Токопроводящие наконечники / Stromdüsen

SPA.140.0114	36 KD	∅ 0,8	M8x30	E-Cu
SPA.140.0313	36 KD	∅ 1,0	M8x30	E-Cu
SPA.140.0442	36 KD	∅ 1,2	M8x30	E-Cu
SPA.140.0445	36 KD	∅ 1,2	M8x30	CuCrZr
SPA.140.0587	36 KD	∅ 1,6	M8x30	E-Cu
SPA.140.0590	36 KD	∅ 1,6	M8x30	CuCrZr
SPA.141.0015	36 KD	∅ 1,2	M8x30	E-Cu do Al



DRUT I AKCESORIA SPAWALNICZE

welding wire and accessories / сварочная проволока и принадлежности /
Schweißdraht und Schweißzubehör

195

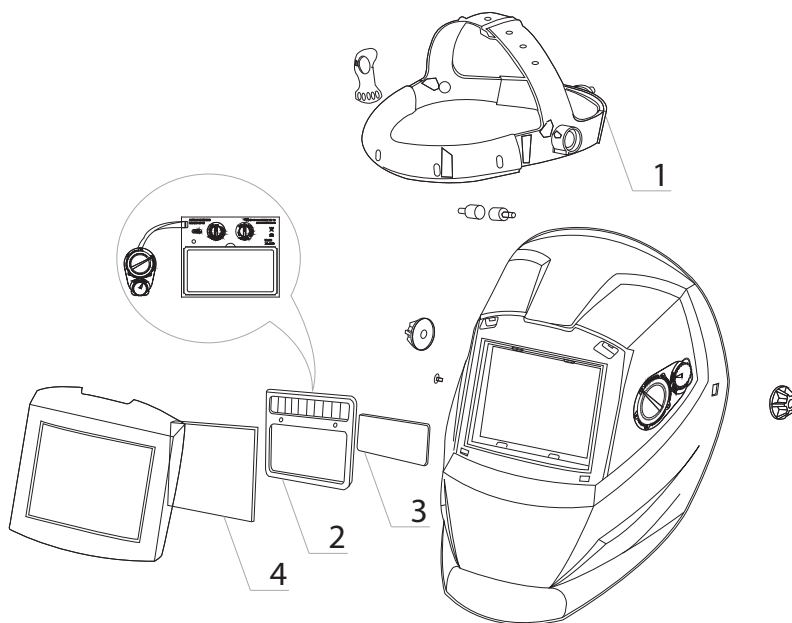

Przyłbica automatyczna Star Wire 1/1/1/2 wg normy EN 379

Automatic welding helmet Star Wire 1/1/1/2 according to EN 379 /

Автоматическая сварочная маска согласно норме EN 379 /

automatic Schweißerschutzhelm Star Wire 1/1/1/2 nach der Norm EN 379

Klasa optyczna (dokładność widzenia)

Optical class

bardzo dobra (klasa 1)

very good (class 1)

Rozproszenie światła

Diffusion of light class

bardzo dobra (klasa 1)

very good (class 1)

Różnice w przepuszczalności światła (jasne lub ciemne obszary w polu widoku)

Variation of luminous transmittance class

bardzo dobra (klasa 1)

very good (class 1)

Zależność kąta na przepuszczalność światła

Angle dependence of luminous transmittance class

dobra (klasa 2)

good (class 2)

Przyłbica automatyczna

Automatic welding helmet / Автоматическая сварочная маска / Automatischer Schweißerschutzhelm

SWM.PRZYŁBICA.01

Przyłbica Star-Wire z systemem ADF

Welding helmet with ADF filter / Сварочная маска с фильтром ADF / Schweißhelm mit ADF Filter

Akcesoria do przyłbicy automatycznej

Accessories for automatic welding helmet / Аксессуары для автоматической сварочной маски / Zubehörteile für automatischen Schweißerschutzhelm

1 SWM.UCHWYT.01

Uchwyt przyłbicy Star-Wire

Headgear / Оголовье маски Star-Wire / Kopfbedeckung

2 SWM.ADF.01

Filtr ADF

Filter ADF / Фильтр ADF / Automatikfilter

3 SWM.INNER.01

Wewnętrzne soczewki ochronne 104.7*53.8*1mm

Inner protection lens 104.7*53.8*1mm / Внутренние защитные линзы 104.7*53.8*1мм / Innere Schutzkassette 104.7*53.8*1mm

4 SWM.OUTER.01

Zewnętrzne soczewki ochronne 110*90*1mm

Outer protection lens 110*90*1mm / Внешние защитные линзы 110*90*1мм / Äußere Schutzkassette 110*90*1mm

cutting steel, InØx-stainles⁶

STAR FLEX

flap disc for steel
STAR FLEX

ART.TLS 125 22 60
EN12413 TYPE



Tarcza do cięcia stali
Cutting disc / Диск для резки / Trennscheibe



	wymiary dimensions / Параметры / Abmessungen	opakowanie packaging / упаковка / Verpackung
TCI 115 10 22	115 x 1,0 x 22	50
TCI 125 10 22	125 x 1,0 x 22	50
TCI 125 16 22	125 x 1,6 x 22	50
TCI 125 25 22	125 x 2,5 x 22	50
TCI 230 20 22	230 x 2,0 x 22	50
TCI 230 30 22	230 x 3,0 x 22	25
TCI 300 30 32	300 x 3,0 x 32	25
TCI 350 35 32	350 x 3,5 x 32	25
TCI 400 40 32	400 x 4,0 x 32	25



TARCZE

discs / диски / Trennscheiben

197

STAR FLEX



Tarcza zdiarna

Grinding disc / Абразивный диск / Schruppscheibe



	wymiary dimensions / Параметры / Abmessungen	opakowanie packaging / упаковка / Verpackung
TZI 125 60 22	125 x 6,0 x 22	25
TZI 230 60 22	230 x 6,0 x 22	10

STAR FLEX

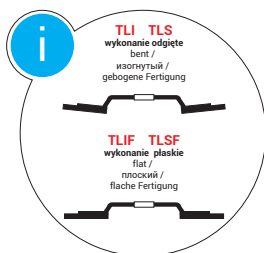

Tarcza listkowa do szlifowania

Flap disc / Лепестковый диск для шлифовки стали / Lamellenschleifscheibe

	wymiary dimensions / Параметры / Abmessungen	opakowanie packaging / упаковка / Verpackung
TLI 125 22 40	125 x 22 x 40	10
TLI 125 22 60	125 x 22 x 60	10
TLI 125 22 80	125 x 22 x 80	10
TLI 125 22 100	125 x 22 x 100	10
TLI 125 22 120	125 x 22 x 120	10
TLIF 125 22 40	125 x 22 x 40	10
TLS 125 22 40	125 x 22 x 40	10
TLS 125 22 60	125 x 22 x 60	10
TLS 125 22 80	125 x 22 x 80	10
TLS 125 22 100	125 x 22 x 100	10
TLS 125 22 120	125 x 22 x 120	10
TLSF 125 22 40	125 x 22 x 40	10



Tarcza listkowa ceramiczna

Ceramic flap disc / Керамический лепестковый диск / Lamellenschleifscheibe Keramik



	wymiary dimensions / Параметры / Abmessungen	opakowanie packaging / упаковка / Verpackung
TLC 125 22 40	125 x 22 x 40	10
TLC 125 22 60	125 x 22 x 60	10
TLC 125 22 80	125 x 22 x 80	10



Tarcza listkowa pachwinowa

do szlifowania stali czarnej i stali nierdzewnej
Zircon curve flap discs / Круг лепестковый для обработки
сварочных швов / Zircon Gebogene Schleiflamellenteller



	wymiary dimensions / Параметры / Abmessungen	opakowanie packaging / упаковка / Verpackung
TLP 125 22 40	125 x 22 x 40	10
TLP 125 22 60	125 x 22 x 60	10
TLP 125 22 80	125 x 22 x 80	10

kod	strona	kod	strona	kod	strona	kod	strona	kod	strona
1xxxx		10.300	15	12.148	21	13.071	32	20.013	44
10.089	12	10.301	15	12.150	21	13.072	32	20.020	44
10.090	12	10.302	15	13.000	24	13.073	32	20.100	45
10.091	12	10.303	15	13.003	24	13.074	32	20.102	45
10.092	12	10.304	15	13.005	24	13.081	34	20.105	45
10.093	12	10.305	15	13.006	24	13.082	34	20.130	45
10.094	12	10.310	15	13.006.01	24	13.090	33	20.148	45
10.095	12	10.311	15	13.007	24	13.091	33	20.149	45
10.096	12	10.312	15	13.008	24	13.092	33	21.010	45
10.097	12	10.313	15	13.009	25	13.093	33	21.011	45
10.098	12	10.315	16	13.010	25	13.094	33	21.024	45
10.099	12	10.316	16	13.011	25	13.096	33	21.025	45
10.100	12	10.317	16	13.012	25	13.097	33	21.116	45
10.101	12	10.320	16	13.013	26	13.100	34	21.117	45
10.102	12	10.321	16	13.013.01	26	13.101	34	21.118	46
10.103	12	10.323	16	13.015	26	13.104	35	21.119	46
10.104	12	10.328	16	13.016	26	13.105	35	21.120	46
10.107	12	10.330	16	13.017	26	13.106	35	21.122	46
10.108	12	10.340	16	13.018	27	13.107	35	21.124	46
10.109	12	11.030	17	13.018.01	27	13.111	36	21.140	46
10.116	12	11.031	17	13.018.02	27	13.112	36	21.141	46
10.125	12	11.032	17	13.020	27	13.113	36	21.145	46
10.130	12	11.041	17	13.023	27	13.190	36	21.147	46
10.200	13	11.042	17	13.025	27	13.191	36	21.900	47
10.201	13	11.051	17	13.026	28	13.192	37	21.901	47
10.202	13	11.052	17	13.028	28	13.198	37	21.902	47
10.203	13	11.061	17	13.029	28	13.200	38	22.001	47
10.204	13	11.062	17	13.030	28	13.202	38	22.002	47
10.205	13	11.091	17	13.032	29	13.203	38	22.003	47
10.206	13	11.231	17	13.033	29	13.204	38	22.004	47
10.207	13	11.232	17	13.034	29	13.209	39	22.005	47
10.208	13	11.241	17	13.035	29	13.210	39	22.013	47
10.209	13	11.242	17	13.037	29	13.241	40	22.019	47
10.210	13	11.331	17	13.038	29	13.248	40	22.020	47
10.211	13	11.332	17	13.040	29	13.249	40	22.021	48
10.215	14	12.010	20	13.041	29	13.250	40	22.022	48
10.216	14	12.080	20	13.042	30	13.251	40	22.053	48
10.220	14	12.081	20	13.045	30	13.252	40	22.100	48
10.221	14	12.082	20	13.046	30	13.253	40	22.103	48
10.224	14	12.083	20	13.048	30	13.256	40	22.104	48
10.226	14	12.084	20	13.056	30	13.315	40	22.105	48
10.230	14	12.111	20	13.057	30	13.323	40	22.107	48
10.231	14	12.112	20	13.058	31	2xxxx		22.150	49
10.240	14	12.113	20	13.059	31	20.001	44	22.151	49
10.241	14	12.115	21	13.060	31	20.003	44	22.200	49
10.242	14	12.118	21	13.061	31	20.010	44	22.201	49
10.243	14	12.124	21	13.067	31	20.010.01	44	22.203	49
10.250	14	12.130	21	13.068	31	20.011	44	22.204	49
10.251	14	12.131	21	13.070	32	20.012	44	22.205	49

kod	strona	kod	strona	kod	strona	kod	strona	kod	strona
22.206	49	30.010	57	31.350	61	34.017	68	40.066	74
22.207	49	30.010.01	57	31.350.12	61	34.020	68	40.067	74
22.208	49	30.020	64	31.350.24	61	34.020.00	68	40.068	74
22.209	49	30.020.01	64	31.350M1	61	34.023	68	40.071	75
23.001	50	30.020.02	64	31.400	61	34.023.00	68	40.071.01	75
23.002	50	30.021	64	31.400.12	61	34.102	69	40.072	75
23.003	50	30.021.01	64	31.400.24	61	34.102.00	69	40.072.01	75
23.004	50	30.021.02	64	31.400M1	61	34.105	69	40.073	75
23.005	50	30.022	64	31.402	61	34.105.00	69	40.077	75
23.006	50	30.022.01	64	31.402M1	61	34.107	69	40.077.02	75
23.007	50	30.022.02	64	31.403	61	34.107.00	69	40.078	75
23.008	50	30.030	64	31.403M1	61	34.111	69	40.078.01	75
23.009	50	30.031	64	31.404	61	34.111.00	69	40.078.02	75
23.010	50	30.032	64	31.404M1	61	34.120	69	40.080	75
23.015	50	30.100	57	32.001	65	34.120.00	69	40.081	75
23.020	50	30.101	57	32.001.00	65	34.221	69	40.083	75
23.021	50	30.101.00	57	32.003	65	34.230	69	40.088.01	76
23.024	51	30.102	57	32.003.00	65	34.231	69	40.089	76
23.025	51	30.102.00	57	32.005	65	4xxxx		40.092	76
23.030	51	30.103	58	32.005.00	65	40.001	72	40.092.01	76
23.031	51	30.103.01	58	32.007	65	40.002	72	40.093	76
23.065	51	30.105	58	32.100	65	40.003	72	40.095	76
24.011	52	30.105.00	58	32.101	65	40.006	72	40.096	76
24.111	52	30.105.01	58	32.111	66	40.007	72	40.097	76
24.112	52	30.105.02	58	32.112	66	40.008	72	40.097.30	76
24.151	52	30.111	59	32.113	66	40.011	72	40.098.01	76
24.254	52	30.111.00	59	32.114	66	40.012	72	40.098.02	76
24.255	52	30.111.01	59	32.115	66	40.013	72	40.098.03	76
24.257	52	30.113	58	32.117	66	40.017	72	40.099.01	76
24.259	52	30.113.01	58	32.200	66	40.018	72	40.099.02	76
24.266	52	30.113.04	58	32.201	66	40.041	73	40.099.03	76
3xxxx		30.114	59	32.202	66	40.045	73	40.099.04	76
30.001	56	30.114.01	59	33.000	67	40.048	73	40.100	76
30.001.00	56	30.115	60	33.001	67	40.048.01	73	40.102	77
30.001.01	56	30.123	58	33.013	67	40.049	73	40.102.01	77
30.001.04	56	30.125	60	33.023	67	40.050	73	40.104	77
30.002	56	30.200	60	33.098	67	40.052	73	40.106	77
30.002.00	56	30.202	60	33.099	67	40.052.02	73	40.110	77
30.002.01	56	30.220	60	33.100	67	40.052.03	73	40.111	77
30.002.02	56	31.101	60	33.201	67	40.053	73	40.112	77
30.002.03	56	31.101.00	60	34.000	68	40.055	73	40.112.01	77
30.003	56	31.102	60	34.002	68	40.056	73	40.117	77
30.003.00	56	31.102.00	60	34.002.00	68	40.058	74	40.118	77
30.003.01	56	31.103	60	34.005	68	40.059	74	40.123	77
30.003.02	56	31.103.00	60	34.008	68	40.060	74	40.125	77
30.003.03	56	31.300.01	61	34.008.00	68	40.060.01	74	40.126	78
30.003.04	56	31.300.01M1	61	34.011	68	40.060.02	74	40.133	78
30.008	57	31.300.12	61	34.011.00	68	40.061	74	40.140	78
30.008.00	57	31.300.24	61	34.014	68	40.065	74	40.150	78

kod	strona	kod	strona	kod	strona	kod	strona	kod	strona
40.151	78	41.307	85	43.506	92	44.053	98	44.206	101
40.153	78	41.315	85	43.507	92	44.054	98	44.220	101
40.154	78	41.316	85	43.508	92	44.060	101	44.230.ZN	100
40.155	78	41.317	85	43.510	92	44.119	98	44.231.ZN	100
40.156	78	41.318	85	43.512	92	44.121	98	44.232.ZN	100
40.157	78	41.400	86	43.515	92	44.122	98	44.233.ZN	100
40.159	78	41.401	86	43.615	93	44.123	98	44.234.ZN	100
40.162	79	41.402	86	43.620	93	44.126	98	44.235.ZN	100
40.170	79	41.403	86	43.625	93	44.127	98	44.236.ZN	100
40.182	79	41.407	86	43.630	93	44.128	98	44.237.ZN	100
40.183	79	41.408	86	43.635	93	44.129	98	44.238.ZN	100
40.200	79	41.409	86	43.640	93	44.134	99	44.239.ZN	100
40.202	79	41.501	87	43.650	93	44.136	99	44.240.ZN	100
40.210	79	41.502	87	43.660	93	44.138	99	44.241.ZN	100
40.211	79	41.503	87	43.660.01	93	44.139	99	44.242.ZN	100
40.300	79	41.504	87	43.670	93	44.140	99	44.243.ZN	100
41.001	82	41.505	87	43.680	93	44.141	99	44.244.ZN	100
41.002	82	41.506	87	43.680.01	93	44.142	99	44.246.ZN	100
41.002.01	82	42.000	90	43.690	93	44.143	99	44.247.ZN	100
41.003	82	42.001	90	43.700	93	44.144	99	44.248.ZN	100
41.004	82	42.003	90	43.700.01	93	44.145	99	44.249.ZN	100
41.005	82	42.004	90	43.720	93	44.146	99	44.251.ZN	100
41.006	82	42.005	90	43.720.01	93	44.146.ZN	99	44.252.ZN	100
41.007	82	42.005.01	90	43.750	93	44.147	99	44.254.ZN	100
41.008	82	42.006	90	43.800.01	93	44.147.ZN	99	44.256.ZN	100
41.011	82	42.007	90	44.001	96	44.148	99	44.257.ZN	100
41.012	82	42.008	90	44.004	96	44.148.ZN	99	44.258.ZN	100
41.021	83	42.011	91	44.006	96	44.149	99	44.259.ZN	100
41.022	83	42.012	91	44.010	96	44.149.ZN	99	5xxxx	
41.023	83	42.013	91	44.011	96	44.150	99	50.000	104
41.024	83	42.030	91	44.013	96	44.150.ZN	99	50.001	104
41.025	83	43.015	92	44.017	96	44.151	99	50.003	104
41.026	83	43.020	92	44.018	96	44.151.ZN	99	50.004	104
41.050	83	43.025	92	44.020	96	44.152	99	50.005	104
41.060	83	43.030	92	44.026	97	44.152.ZN	99	50.006	104
41.070	83	43.035	92	44.029	97	44.153	99	50.009	104
41.102	84	43.040	92	44.034	97	44.154	99	50.010	104
41.104	84	43.050	92	44.036	97	44.155	99	50.011	104
41.105	84	43.120	92	44.038	97	44.155.ZN	99	50.012	104
41.106	84	43.125	92	44.039	97	44.156	99	50.014	104
41.111	84	43.130	92	44.040	97	44.157	100	50.021	104
41.114	84	43.135	92	44.043	97	44.158	100	50.021.01	104
41.115	84	43.140	92	44.046	98	44.159	100	50.022	104
41.202	84	43.150	92	44.047	98	44.200	101	50.023	104
41.204	84	43.230	92	44.048	98	44.201	101	50.024	104
41.205	84	43.240	92	44.049	98	44.202	101	50.025	104
41.206	84	43.250	92	44.050	98	44.203	101	50.029	105
41.207	84	43.504	92	44.051	98	44.204	101	50.030	105
41.306	85	43.505	92	44.052	98	44.205	101	50.031	105

kod	strona	kod	strona	kod	strona	kod	strona	kod	strona
50.042	105	50.176	39, 109	51.073	114	51.252	119	52.216	127
50.043	105	50.182	109	51.074	114	51.253	120	52.217	127
50.051	105	50.183	109	51.077	114	51.254	120	52.300	128
50.054	105	50.188	110	51.078	114	51.418	120	52.301	128
50.055	105	50.189	110	51.079	115	51.427	120	52.305	128
50.056	105	50.190	110	51.080	115	51.449	120	52.406	128
50.062	106	50.195	110	51.082	115	51.451	120	52.420	128
50.063	106	50.196	110	51.083	115	51.452	120	53.000	128
50.064	106	50.197	110	51.097	115	52.003	124	53.008	128
50.095	106	50.200	110	51.098	115	52.004	124	53.009	128
50.096	106	50.201	110	51.099	115	52.005	124	55.001	129
50.097	106	50.210	110	51.101	115	52.006	124	55.003	129
50.100	106	50.211	111	51.102	115	52.009	124	55.005	129
50.101	106	50.212	111	51.103	115	52.010	124	55.006	129
50.102	106	50.213	111	51.104	115	52.011	124	55.007	129
50.103	106	50.216	111	51.105	115	52.012	124	55.008	129
50.104	107	50.217	111	51.106	116	52.013	124	55.009	129
50.105	107	50.218	111	51.107	116	52.014	124	55.030	130
50.106	107	50.219	111	51.108	116	52.015	124	55.031	130
50.107	107	50.229	112	51.108.01	116	52.016	124	55.050	131
50.108	107	50.230	112	51.110	116	52.017	125	55.100	131
50.109	107	50.236	112	51.113	116	52.018	125	55.101	131
50.110	107	50.237	112	51.114	116	52.019	125	55.102	131
50.111	107	50.238	112	51.115	116	52.020	125	55.103	131
50.112	107	50.239	112	51.116	116	52.021	125	55.104	131
50.122	107	50.240	112	51.121	117	52.022	125	55.105	131
50.124	107	50.241	112	51.122	117	52.023	125	55.200	131
50.133	108	50.242	112	51.123	117	52.024	125	56.010.12	134
50.134	108	50.243	112	51.124	117	52.025	125	56.010.12.01	134
50.136	108	50.244	113	51.125	117	52.026	125	56.020.12	134
50.138	108	50.245	113	51.126	117	52.029	125	56.020.12.01	134
50.143	108	50.255	113	51.127	117	52.030	125	56.030.12	134
50.143.01	108	50.256	113	51.128	117	52.034	126	56.040.12	134
50.143.02	108	50.257	113	51.129	118	52.043.01	126	56.040.12.01	134
50.150	108	50.258	113	51.130	118	52.044	126	56.050.12	135
50.151	108	51.003	114	51.133	118	52.047	126	56.050.12.01	135
50.152	108	51.004	114	51.134	118	52.049	126	56.060.12	135
50.153	108	51.015	114	51.140	118	52.050	126	56.060.12.01	135
50.154	108	51.016	114	51.143	118	52.130	126	56.070.12	135
50.156	109	51.017	114	51.144	118	52.131	126	56.070.12.01	135
50.157	109	51.018	114	51.145	118	52.132	126	56.080.12	135
50.158	109	51.059	114	51.147	118	52.133	126	56.080.12.01	135
50.159	109	51.060	114	51.153	119	52.134	126	56.090.12	135
50.160	109	51.061	114	51.154	119	52.139	126	56.090.12.01	135
50.161	109	51.062	114	51.235	119	52.201	127	6xxxx	
50.162	109	51.063	114	51.236	119	52.202	127	61.100	140
50.165	109	51.064	114	51.240	119	52.203	127	61.101	140
50.166	109	51.069	114	51.241	119	52.211	127	61.102	140
50.175	39, 109	51.070	114	51.251	119	52.212	127	61.103	140

kod	strona	kod	strona	kod	strona	kod	strona	kod	strona
61.104	140	61.262	145	63.017	158	63.127.90.50	165	63.191.72.00	166
61.105	140	61.263	145	63.018	158	63.128.72.50	165	63.191.90.00	166
61.106	140	61.264	145	63.020	158	63.128.90.50	165	63.192.72.00	166
61.107	140	61.265	145	63.021	155	63.129.00.00	165	63.192.90.00	166
61.112	141	61.271	145	63.022	155	63.130.00.50	165	63.193.90.00	167
61.114	141	61.272	145	63.024	159	63.130.72.50	165	63.194.90.00	167
61.114.01	141	61.273	145	63.025	159	63.130.90.50	165	64.003	168
61.116	141	61.274	145	63.027	158	63.131.00.50	165	64.004	168
61.116.01	141	61.300	145	63.028	158	63.131.72.50	165	64.005	168
61.116.02	140	61.301	145	63.029	155	63.131.90.50	165	64.006	169
61.118	141	61.302	146	63.030	155	63.134.00.00	165	64.007	169
61.118.01	141	61.303	146	63.031	156	63.135.00.00	165	64.008	169
61.120	141	61.304	146	63.031.01	156	63.136.72.50	165	64.011	170
61.120.01	141	61.305	146	63.032	156	63.136.90.50	165	64.012	170
61.120.02	140	61.306	146	63.034	156	63.137.72.50	165	64.013	170
61.120.03	141	61.307	146	63.035	156	63.137.90.50	165	64.014	168
61.124	141	61.308	146	63.036	156	63.138.72.00	162	64.015	168
61.124.01	141	61.314	147	63.038	156	63.138.90.00	162	64.016	168
61.124.02	140	61.315	147	63.040	162	63.139.72.00	162	64.017	168
61.124.03	141	61.316	147	63.041	162	63.139.90.00	162	64.018	168
61.125	141	61.317	147	63.044	162	63.140.72.00	162	64.019	169
61.125.01	141	61.318	147	63.045	162	63.140.90.00	162	64.020	170
61.127	141	61.320	148	63.046	162	63.141.90.00	162	64.021	170
61.127.01	141	61.321	148	63.047	162	63.142	162	64.022	170
61.130	141	61.322	148	63.101.00.00	163	63.146.00.00	164	64.023	170
61.130.01	141	61.323	148	63.102.72.50	163	63.147.90.50	164	64.024	170
61.131	141	61.324	149	63.102.90.50	163	63.148.90.50	164	64.035	171
61.131.01	141	61.325	149	63.103.72.50	163	63.149.72.50	164	64.036	171
61.135	141	61.326	149	63.103.90.50	163	63.150.72.50	164	64.037	171
61.135.01	141	62.101	150	63.108.00.00	163	63.151.00.00	165	64.040	171
61.140	141	62.102	150	63.109.72.50	163	63.152.00.00	165	64.041	171
61.140.01	141	62.103	150	63.109.90.50	163	63.153.72.50	165	64.042	171
61.201	142	62.104	150	63.110.72.50	163	63.153.90.50	165	64.043	171
61.202	142	63.001	154	63.110.90.50	163	63.154.72.50	165	64.044	171
61.203	142	63.002	157	63.111.00.00	163	63.154.90.50	165	64.800	169
61.211	142	63.003	154	63.112.90.50	163	63.165.72.50	163	64.801	169
61.212	142	63.005	154	63.113.90.50	163	63.166.72.50	163	65.200	174
61.221.02	143	63.006	154	63.114.00.00	164	63.180.72.00	167	65.202	174
61.222.02	143	63.006.01	154	63.115.90.35	164	63.180.90.00	167	65.203	174
61.223.02	143	63.007	154	63.116.90.35	164	63.181.72.00	167	65.210	174
61.224.02	143	63.008	157	63.117.00.00	164	63.181.90.00	167	65.211	174
61.251	144	63.009	157	63.118.00.00	164	63.182.72.00	167	65.212	175
61.252	144	63.010	157	63.119.72.50	164	63.182.90.00	167	65.213	175
61.253	144	63.011	157	63.119.90.50	164	63.185.00.00	164	65.250	175
61.254	144	63.012	154	63.120.72.50	164	63.186.90.50	164	65.257.01	176
61.255	144	63.013	155	63.120.90.50	164	63.187.90.50	164	65.259	176
61.256	144	63.013.01	155	63.125.00.00	165	63.188.90.00	166	66.003.01	177
61.257	144	63.015	157	63.126.00.00	165	63.189.90.00	166	66.004.01	177
61.261	145	63.016	158	63.127.72.50	165	63.190.90.00	166	66.006.01	177

kod	strona	kod	strona	kod	strona	kod	strona	kod	strona
66.050	178	70.123	185	75.010	186	SPA.140.0242	194	TCI 125 10 22	196
66.051	178	70.222	184	75.013	186	SPA.140.0245	194	TCI 125 16 22	196
66.052	179	70.222.01	184	75.018	186	SPA.140.0253	194	TCI 125 25 22	196
66.053	179	70.222.02	184	75.025	187	SPA.140.0313	194	TCI 230 20 22	196
66.060	178	70.321	184	75.030	187	SPA.140.0379	194	TCI 230 30 22	196
66.070	179	70.321.01	184	75.041	187	SPA.140.0382	194	TCI 300 30 32	196
66.075	179	70.321.02	184	75.041.01	187	SPA.140.0387	194	TCI 350 35 32	196
7xxxx		70.322	184	5xxxx		SPA.140.0442	194	TCI 400 40 32	196
70.001	182	70.322.01	184	SP.001.08	190	SPA.140.0445	194	TLC 125 22 40	197
70.001.01	182	70.322.02	184	SP.001.08X	191	SPA.140.0587	194	TLC 125 22 60	197
70.001.02	182	70.323	185	SP.002.10	190	SPA.140.0590	194	TLC 125 22 80	197
70.002	182	70.323.01	185	SP.002.10X	191	SPA.141.0015	194	TLI 125 22 100	197
70.002.01	182	70.901	182	SP.003.12	190	SPA.142.0001	192	TLI 125 22 120	197
70.002.02	182	70.901.01	182	SP.003.12X	191	SPA.142.0003	192	TLI 125 22 40	197
70.003	182	70.901.02	182	SP.004.08X	191	SPA.142.0020	192	TLI 125 22 60	197
70.003.01	182	70.911	182	SP.005.10X	191	SPA.142.0022	192	TLI 125 22 80	197
70.021	184	70.911.01	182	SP.010.12	190	SPA.145.0075	193	TLIF 125 22 40	197
70.021.01	184	70.911.02	182	SP.011.10X	191	SPA.145.0076	193	TLP 125 22 40	197
70.021.02	184	71.001	186	SPA.002.0058	192	SPA.145.0078	193	TLP 125 22 60	197
70.022	184	71.300	186	SPA.002.0078 L	192	SPA.145.0080	193	TLP 125 22 80	197
70.022.01	184	71.410	186	SPA.003.0013	192	SPA.145.0085	193	TLS 125 22 100	197
70.022.02	184	71.410.01	186	SPA.012.0183	193	SPP.003.12X	191	TLS 125 22 120	197
70.101	183	71.410.02	186	SPA.014.0023	193	SWM.ADF.01	195	TLS 125 22 40	197
70.102	183	74.012	186	SPA.030.0145	193	SWM.INNER.01	195	TLS 125 22 60	197
70.103	183	74.015	186	SPA.140.0008	194	SWM.OUTER.01	195	TLS 125 22 80	197
70.104	183	74.015.01	186	SPA.140.0051	194	SWM.PRZYŁBICA.01	195	TLSF 125 22 40	197
70.105	183	74.020	186	SPA.140.0054	194	SWM.UCHWYT.01	195	TZI 125 60 22	197
70.121	185	74.112	186	SPA.140.0059	194	7xxxx		TZI 230 60 22	197
70.122	185	74.115	186	SPA.140.0114	194	TCI 115 10 22	196		

POSTAL
STEEL GROUP
BONMARIO 



POSTAL[®]
STEEL GROUP

BONMARIO 

Postal Steel Group Polska Sp. z o.o.
dawniej POSTAL STEEL GROUP Sp. z o.o. Sp. k.
ul. Sowie 6 | „Sowie” Park Przemysłowy
62-080 Tarnowo Podgórne, POLAND
T: +48 61 65 25 900, +48 510 915 915
zamowienia@postal.pl

www.bonmario.com



POSTAL[®]
STEEL GROUP

BONMARIO 

PINOX

PSG

STAR[®]
FLEX 

STAR[®]
WIRE 

Platinum

POSTAL[®]
STEEL GROUP

www.postal.pl

